



Dorema

COLLECTION 2023

Your holiday starts here!

www.dorema.co.uk



ONYX270

Where space and design meet

WELCOME TO DOREMA

Established since 1987, for more than 35 years, Dorema have been specialising in the design and manufacturing of quality caravan and motorhome awnings.

As a leading manufacturer within the leisure industry, we source a variety of high-performance materials to produce our fantastic portfolio of products. From lightweight to the most durable, each awning is thoroughly checked prior to receiving its Dorema Quality Certificate. This stamp of approval is a recognised standard that is envied within our industry.

We strive to incorporate the very latest technologies and to introduce those of the future. Each of our awnings are designed to suit the differing needs and demands of today's and tomorrow's campers.

Our passion is to enhance space and create an extra dimension to the joy of camping.

Dorema's collection of awnings caters to all tastes and our nationwide network of dealers are there to assist you in making the right choice.

It does not stop there, our wonderful team in the UK are able to share their wealth of knowledge. They are more than happy to be of assistance and to guide you to your new Dorema awning.

"Your holiday starts here!"



Our awnings and canopies are developed and produced in our own state of the art production facilities in Europe.



We stand for quality and service. Dorema uses the very latest technologies to ensure that our products are trouble free and that you, the customer, are able to have many happy holidays.



DETAILS

QUALITY IS IN THE DETAIL

TENCATE OUTDOOR FABRICS

Dorema awnings are manufactured using, world leading, TenCate outdoor fabrics which provide optimal all round protection for years of enjoyment.

DormaTex is coated polyester material, which has been exclusively designed by TenCate for Dorema Awnings.

YKK Opti

Doréma only uses the high quality zippers of YKK and Optilon to ensure ease of use for years to come.

SIOEN INDUSTRIES

SIOEN is the World market leader in coated technical textiles.

Standard with all Dorema awnings: Draught Skirt / Wheel Arch Cover / Ladder Straps / Heavy Duty Nylon Pegs / Canvas & Frame Bags.



SAFE LOCK SYSTEM

SafeLock System fitted as standard to attach the optional extra SafeLock System Kit.

Caravans

Measure your caravan through the awning rail from ground to ground (A-B-C) as shown in the diagram below. Then check your measurement against the chart. This will provide you with the Dorema awning size required.



Seasonal Caravanners please note:

Dorema strongly recommend that anyone seasonally siting their awning should measure the caravan on the seasonal pitch prior to ordering their awning, (for example, a pitch with decking could alter the awning size required).

SIZE	A-MEASUREMENT CM
2	675 – 700
3	700 – 725
4	725 – 750
5	750 – 775
6	775 – 800
7	800 – 825
8	825 – 850
9	850 – 875
10	875 – 900
11	900 – 925
12	925 – 950

SIZE	A-MEASUREMENT CM
13	950 – 975
14	975 – 1000
15	1000 – 1025
16	1025 – 1050
17	1050 – 1075
18	1075 – 1100
19	1100 – 1125
20	1125 – 1150
21	1150 – 1175
22	1175 – 1200



EASYGRIP

EasyGrip system for rapid locking and ease of frame tensioning.



QUICKLOCK PADS INCLUDED



EASY AIR FRAME

Easy Air Frame system.



HAND PUMP INCLUDED



TOURING

TOURING	
INTENDED USE	Awning suitable for touring holidays and short breaks. Up to 12 weeks per year between March to September.
SUITABLE FRAMES	Steel / ALU / FibreTech Plus / EAF System (Easy Air Frame)

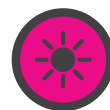

SEASONAL

SEASONAL	
INTENDED USE	Awning suitable for long periods of continuous use between March to October.
SUITABLE FRAMES	25 mm or 28 mm Steel / EAF System



WINTER

WINTER	
INTENDED USE	Made from heavy duty PVC materials suitable for winter conditions from October to March.
SUITABLE FRAMES	Steel

DOREMA CONTENT

FULL AWNINGS (poled) PAGE

- Daytona 240 4-5
- Garda 240 & Garda 240 De Luxe 6-7
- Emerald 270 8-9
- Onyx 270 10-11
- President 250, XL300, XL280 De Luxe 12-13
- Royal 350 De Luxe 14-15

PORCH AWNINGS (poled)

- Introduction 16-17
- Davos / Oslo 18
- Mistral / Mistral XL 19
- Safari 20
- Omega De Luxe 21
- Quattro 225, 275 & 380, 430 22-23

AIR AWNINGS

- Introduction 24-25

Full Awnings

- Daytona Air 26-27
- Luxor Air 280 28-29
- Horizon Air De Luxe 30-31

Porch Awnings

- Magnum Air Force All Season 32-33

SUN CANOPIES

- Introduction 34
- Uni, Monaco & Nice 35
- Panorama 36
- Mondial 37
- Palma 38

STARLON CARPET, FRAMES & ACCESSORIES

39-43

DAYTONA 240

The best for less

European touring quality coated polyester / Beading to attach Palma awning canopy

Technical Data:

Depth:

Daytona 240 240 cm

Sizes: 750 - 1125

Colour: charcoal / grey

Standard frame: 25 mm EasyGrip steel

Material Roof: European touring quality coated polyester.

Material Sides: TenCate touring quality coated polyester.

Frontpanels: Both front panels are fitted with a door and can be rolled down or zipped out.

Sidepanels: Both panels are fitted with a door and can be zipped out, part fly screen to one side panel.

Combined weight (canvas + standard frame):

Daytona 240

Size 5 = 31 kg / Size 19 = 47 kg (approx.)

FROM
£822



Daytona 240



TOURING



EASYGRIP



SAFE LOCK SYSTEM



QUICKLOCK PADS INCLUDED



DAYTONA 240

Touring

Optional Extras:

- SafeLock System Kit
- Lightweight FibreTech Plus EasyGrip frame upgrade
- Annex
- Inner tent

- Roof Support poles
- Stormpoles
- Veranda pole
- Starlon carpet
- Palma awning canopy

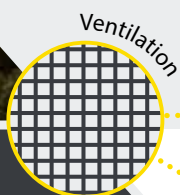

Ventilation

Front apex
Part fly screen to one side panel



Annex 215 x 130 cm



SIZE	CM	DAYTONA 240
5	750 - 775	£822
6	775 - 800	£865
7	800 - 825	£894
8	825 - 850	£938
9	850 - 875	£967
10	875 - 900	£997
11	900 - 925	£1053
12	925 - 950	£1083
13	950 - 975	£1111
14	975 - 1000	£1142
15	1000 - 1025	£1183
16	1025 - 1050	£1213
17	1050 - 1075	£1256
18	1075 - 1100	£1302
19	1100 - 1125	£1314

FRAME UPGRADE COST	
FIBRETECH PLUS EASYGRIP FRAME 5-9	£132
FIBRETECH PLUS EASYGRIP FRAME 10-14	£197
FIBRETECH PLUS EASYGRIP FRAME 15-17	£238
FIBRETECH PLUS EASYGRIP FRAME 18-19	£246

OPTIONAL EXTRAS	
ANNEX	£399
ALU FRAME UPGRADE FOR ANNEX	£41
SAFELock SYSTEM KIT	£33
INNER TENT	£109

DAYTONA IS NOT RECOMMENDED FOR SEASONAL SITE USE

GARDA 240 & 240DELUXE

Elegant and practical in design

Great for both seasonal sites and touring use / European TenCate materials

Garda 240 De Luxe: External zipped privacy blinds fitted as standard

Technical Data:

Depth:

Garda 240 240 cm

Garda 240 De Luxe 240 cm

Sizes: 825 - 1125

Colour: charcoal / grey

Standard frame: 25 mm EasyGrip steel

Material Roof: TenCate All Season coated polyester.

Material Sides: TenCate All Season coated polyester.

Frontpanels: Both front panels are fitted with a door and can be rolled down or zipped out.

Sidepanels: Both panels are fitted with a door and can be zipped out.

Part fly screen fitted to both side panels.

Privacy Blinds: External zipped privacy blinds fitted to De Luxe model only.

Combined weight (canvas + standard frame):

Garda 240 Size 8 = 33 kg / Size 19 = 48 kg

Garda 240 De Luxe Size 8 = 35 kg / Size 19 = 51 kg

FROM
£1174



Garda 240 De Luxe



Garda 240 with Annex



SEASONAL



EASYGRIP



SAFE LOCK SYSTEM



QUICKLOCK PADS INCLUDED



GARDA 240 & 240DELUXE

Seasonal

Optional Extras:

- Canopy poles
 - SafeLock System Kit
 - 28 mm EasyGrip steel frame upgrade
 - Lightweight FibreTech Plus EasyGrip frame upgrade
 - Annex
 - Annex De Luxe
- (Both annexes feature our double zip system to refit side panel)*

- Inner tent
- Roof Support poles
- Stormpoles
- Veranda pole
- Starlon carpet
- Palma awning canopy



Annex De Luxe 215 x 130 cm
(with rear door)

Ventilation

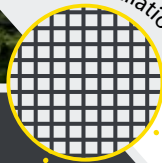

Front apex
Part fly screen to both side panels



Garda 240 De Luxe

SIZE	CM	GARDA 240	GARDA 240 DLX
8	825 – 850	£1174	£1325
9	850 – 875	£1237	£1397
10	875 – 900	£1265	£1429
11	900 – 925	£1309	£1474
12	925 – 950	£1340	£1500
13	950 – 975	£1365	£1561
14	975 – 1000	£1429	£1633
15	1000 – 1025	£1500	£1678
16	1025 – 1050	£1531	£1709
17	1050 – 1075	£1561	£1734
18	1075 – 1100	£1589	£1796
19	1100 – 1125	£1620	£1824

FRAME UPGRADE COST	
28 MM EASYGRIP STEEL FRAME 8-9	£58
28 MM EASYGRIP STEEL FRAME 10-14	£56
28 MM EASYGRIP STEEL FRAME 15-17	£77
28 MM EASYGRIP STEEL FRAME 18-19	£77
FIBRETECH PLUS EASYGRIP FRAME 8-9*	£132
FIBRETECH PLUS EASYGRIP FRAME 10-14*	£197
FIBRETECH PLUS EASYGRIP FRAME 15-17*	£238
FIBRETECH PLUS EASYGRIP FRAME 18-19*	£246

OPTIONAL EXTRAS	
ANNEX	£499
ANNEX DE LUXE (WITH REAR DOOR)	£529
ALU FRAME UPGRADE FOR ANNEX	£41
SAFELock SYSTEM KIT	£33
INNER TENT	£109

*THE FIBRETECH PLUS FRAME OPTIONS ARE NOT SUITABLE FOR SEASONAL SITE USE

EMERALD 270

Cut to perfection!

Very latest modern and unique design / Detachable mud wall / Extra 270cm depth

Technical Data:

Depth:	270 cm
Sizes:	825 - 1200
Colour:	charcoal / grey
Standard frame:	28 mm EasyGrip steel

Canopy poles supplied as standard on all sizes

Material Roof: TenCate All Season coated polyester, printed pattern design on the inside.

Material Sides: TenCate All Season heavy quality coated polyester.

Frontpanels: Both front panels are fitted with a door and can be rolled down or zipped out.

Sidepanels: Both panels are fitted with a door and can be zipped out. Full fly screen fitted to both side panels.

Combined weight (canvas + standard frame):
Emerald 270 Size 8 = 44 kg / Size 22 = 68 kg

FROM
£1724



Front and side panels removed to create a sun canopy



*Front apex
Full fly screen to both side panels*

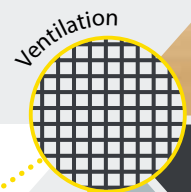

Ventilation



SEASONAL



EASYGRIP



SAFE LOCK SYSTEM



QUICKLOCK PADS INCLUDED



TENCATE
OUTDOOR FABRICS

YKK

EMERALD 270

Seasonal

FULL
AWNINGS



Optional Extras:

- SafeLock System Kit
 - Lightweight FibreTech Plus EasyGrip frame
 - Annex De Luxe XL
 - Inner tent XL
- (Annex De Luxe XL features our double zip system to refit side panel)*

- Roof Support poles
- Stormpoles
- Veranda pole
- Starlon carpet
- Palma awning canopy



Reinforced anchor strap fitted to all four corners



Annex De Luxe XL
250 x 150 cm



Emerald 270 with veranda effect

SIZE	CM	EMERALD 270
8	825 - 850	£1724
9	850 - 875	£1793
10	875 - 900	£1850
11	900 - 925	£1907
12	925 - 950	£1949
13	950 - 975	£1977
14	975 - 1000	£2033
15	1000 - 1025	£2131
16	1025 - 1050	£2187
17	1050 - 1075	£2230
18	1075 - 1100	£2270
19	1100 - 1125	£2315
20	1125 - 1150	£2355
21	1150 - 1175	£2384
22	1175 - 1200	£2524

FRAME UPGRADE COST	
FIBRETECH PLUS EASYGRIP FRAME 5-9*	£111
FIBRETECH PLUS EASYGRIP FRAME 10-14*	£108
FIBRETECH PLUS EASYGRIP FRAME 15-17*	£124
FIBRETECH PLUS EASYGRIP FRAME 18-22*	£125

OPTIONAL EXTRAS	
ANNEX DE LUXE XL	£629
ALU FRAME UPGRADE FOR ANNEX	£41
SAFELOCK SYSTEM KIT	£33
INNER TENT XL	£136

*THE FIBRETECH PLUS FRAME OPTION IS NOT SUITABLE FOR SEASONAL SITE USE

ONYX270

ELEGANT AND SLEEK MODERN CURVED DESIGN

The Onyx 270 is part of our 'Gem' collection. Its curved lines are wonderfully complimented by the sleek and elegant design.

Keeping in line with our passion, the 270cm depth with the extra deep sun canopy enhances space and creates an extra dimension to the joy of camping.

This fantastic awning incorporates our unique detachable mud wall system for easy maintenance.

Equipped with the latest technologies, this truly amazing fullsize awning caters to the differing needs and demands of today's and tomorrow's campers.

FROM
£1964

- OPTIONAL ZIPPED ON SUN CANOPY •
- DETACHABLE MUD WALLS •
- EXTRA 270CM DEPTH •



SEASONAL



EASYGRIP



SAFE LOCK SYSTEM



QUICKLOCK PADS INCLUDED



Onyx 270 with Onyx sun canopy



ONYX 270

Seasonal



Onyx 270 with sun canopy and side panels

Technical Data:

- Depth:** 270 cm + 50 cm canopy
- Sizes:** 850 - 1050
- Colour:** charcoal / grey
- Frame:** 28 mm EasyGrip steel
- Combined weight (canvas + frame):**
 - Onyx 270 Size 9 = 56 kg / Size 16 = 74 kg
 - Onyx 270 sun canopy 20 kg (approx.)

Material Roof: TenCate All Season coated polyester, printed pattern design on the inside.

Material Sides: TenCate All Season heavy quality coated polyester.

Frontpanels: Both front panels are fitted with a door and can be rolled down or zipped out.

Sidepanels: Both panels are fitted with a door and can be zipped out. Full fly screen fitted to both side panels.

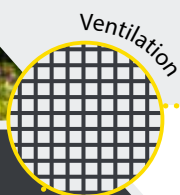

Ventilation

Full fly screen to both side panels
2 x triangular fly screens fitted to the front of the awning

Optional Extras:

- SafeLock System Kit
- Annex De Luxe XL
- Inner tent XL
- Roof Support poles
- Stormpoles
- Veranda pole
- Starlon carpet
- Onyx sun canopy (depth 200 cm)
- Onyx sun canopy side panel set

(Annex De Luxe XL features our double zip system to refit side panel)

Annex De Luxe XL
250 x 150 cm

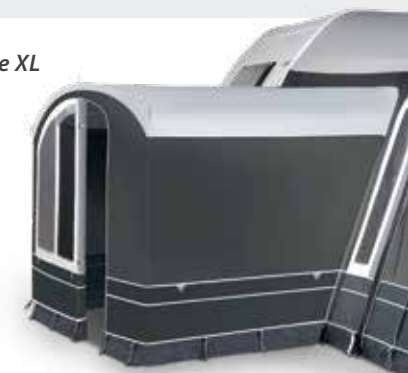

Onyx 270 with veranda effect

SIZE	CM	ONYX AWNING	CANOPY STEEL
9	850 - 875	£1964	£616
10	875 - 900	£2017	£644
11	900 - 925	£2088	£670
12	925 - 950	£2146	£702
13	950 - 975	£2243	£729
14	975 - 1000	£2315	£771
15	1000 - 1025	£2384	£798
16	1025 - 1050	£2454	£841

OPTIONAL EXTRAS	PRICE
SUN CANOPY SIDE PANEL SET	£207
ANNEX DE LUXE XL	£644
SAFELOCK SYSTEM KIT	£33
INNER TENT XL	£123

*THE FIBRETECH PLUS FRAME OPTION IS NOT SUITABLE FOR SEASONAL SITE USE

PRESIDENT 250, XL300 & XL280DELUXE

Perfection is reflected in the detail

Ultimate European quality awning for seasonal sites or touring use / Printed pattern on inside of roof / Latest DormaTex TenCate materials / External zipped privacy blinds fitted as standard on XL280 De Luxe only

Technical Data:

Depth:

President 250 250 cm

President XL 280 DLX 280 cm

President XL 300 300 cm

Sizes: 775 - 1200

Colour: charcoal / grey

Standard frame: 28 mm EasyGrip steel

Privacy Blinds: External zipped privacy blinds fitted to De Luxe model only.

Canopy poles supplied as standard on all sizes

Material Roof: TenCate All Season coated polyester, printed pattern design on the inside.

Material Sides: DormaTex TenCate All Season coated polyester.

Frontpanels: Both front panels are fitted with a door and can be rolled down or zipped out.

Sidepanels: Both panels are fitted with a door and can be rolled down or zipped out. Part fly screen fitted to both side panels.

Combined weight (canvas + standard frame):

President 250 Size 6 = 38 kg / Size 22 = 60 kg (approx.)

President XL 280 DLX Size 6 = 41 kg / Size 22 = 64 kg (approx.)

President XL 300 Size 6 = 42 kg / Size 22 = 64 kg (approx.)

Ventilation

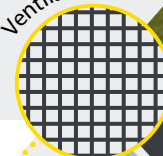

Front apex
Part fly screen to both side panels



President 250



President XL300

FROM
£1497



SEASONAL



EASYGRIP



SAFE LOCK SYSTEM



QUICKLOCK PADS INCLUDED



TENCATE
OUTDOOR FABRICS

YKK

PRESIDENT 250, XL300 & XL280 DELUXE

Seasonal



Annex
215 x 130 cm

Optional Extras:

- SafeLock System Kit
 - Lightweight FibreTech Plus EasyGrip frame
 - Annex
 - Annex De Luxe
- (Both annexes feature our double zip system to refit side panel)

- Inner tent
- Roof Support poles
- Stormpoles
- Veranda pole
- Starlon carpet
- Palma awning canopy



Annex De Luxe
215 x 130 cm

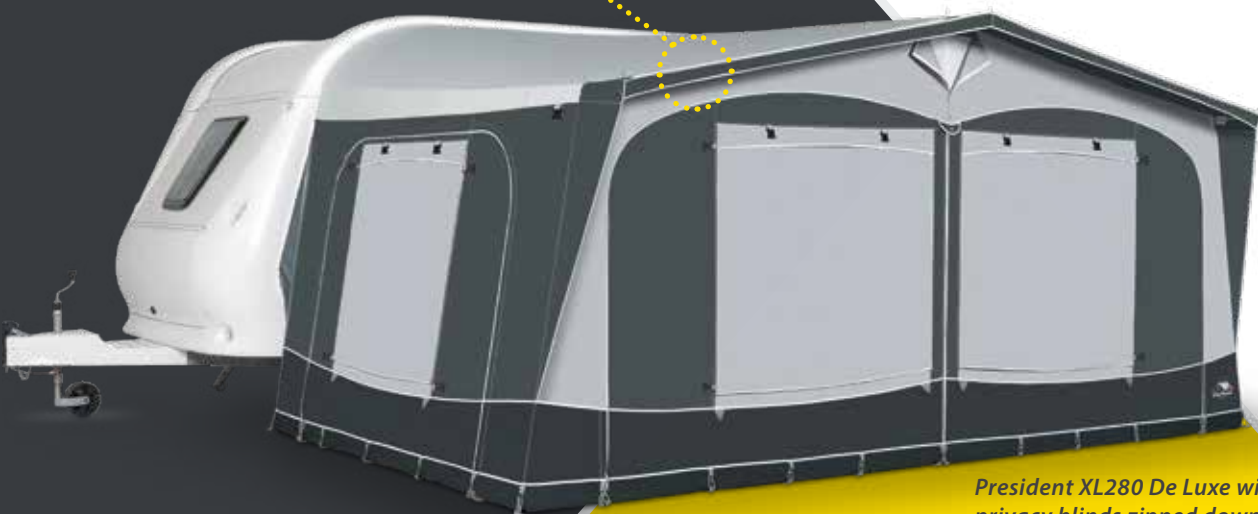
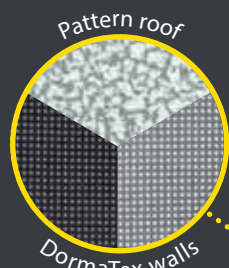

President XL280 De Luxe with privacy blinds zipped down

SIZE	CM	PRESIDENT 250	PRESIDENT XL300	PRESIDENT XL280 DLX
6	775 - 800	£1497	£1628	£1688
7	800 - 825	£1542	£1674	£1747
8	825 - 850	£1586	£1716	£1806
9	850 - 875	£1615	£1777	£1894
10	875 - 900	£1703	£1850	£1983
11	900 - 925	£1733	£1909	£2041
12	925 - 950	£1762	£1953	£2070
13	950 - 975	£1820	£2011	£2129
14	975 - 1000	£1922	£2087	£2205
15	1000 - 1025	£1983	£2144	£2306
16	1025 - 1050	£2026	£2187	£2351
17	1050 - 1075	£2056	£2232	£2410
18	1075 - 1100	£2082	£2291	£2451
19	1100 - 1125	£2146	£2318	£2509
20	1125 - 1150	£2174	£2362	£2553
21	1150 - 1175	£2215	£2406	£2597
22	1175 - 1200	£2260	£2451	£2642

FRAME UPGRADE COST	
FIBRETECH PLUS EASYGRIP FRAME 6-9*	£111
FIBRETECH PLUS EASYGRIP FRAME 10-14*	£108
FIBRETECH PLUS EASYGRIP FRAME 15-17*	£125
FIBRETECH PLUS EASYGRIP FRAME 18-22*	£125

OPTIONAL EXTRAS	
ANNEX	£543
ANNEX DE LUXE (WITH REAR DOOR)	£589
ALU FRAME UPGRADE FOR ANNEX*	£41
SAFELock SYSTEM KIT	£33
INNER TENT	£109

*THE FIBRETECH PLUS FRAME OPTION IS NOT SUITABLE FOR SEASONAL SITE USE

ROYAL 350DELUXE

The ultimate awning for the seasonal camper

The Regal awning of our entire collection, this model combines high quality and space with versatility

Technical Data:

Depth: 350 cm
Sizes: 825 - 1200
Colour: charcoal /grey
Standard frame: 28 mm EasyGrip steel

Privacy Blinds: External zipped privacy blinds fitted to all windows.

Front door panel can be positioned left or right hand side.
Canopy poles supplied as standard on all sizes.

Material Roof: TenCate All Season coated polyester, printed pattern design on the inside.

Material Sides: DormaTex, TenCate All Season coated polyester

Frontpanels: Both panels can be rolled down or zipped out. They can also be positioned forward to create an extra deep 350 cm deep awning or stepped back, to create a 240 cm deep awning with an extra large canopy.

Sidepanels: Both panels are fitted with a door and can be rolled down or zipped out.

Combined weight (canvas + standard frame):

Royal 350 De Luxe Size 8 = 59 kg / Size 22 = 85 kg (approx.)

FROM
£2322

Ventilation

Front apex
 Part fly screen to both side panels

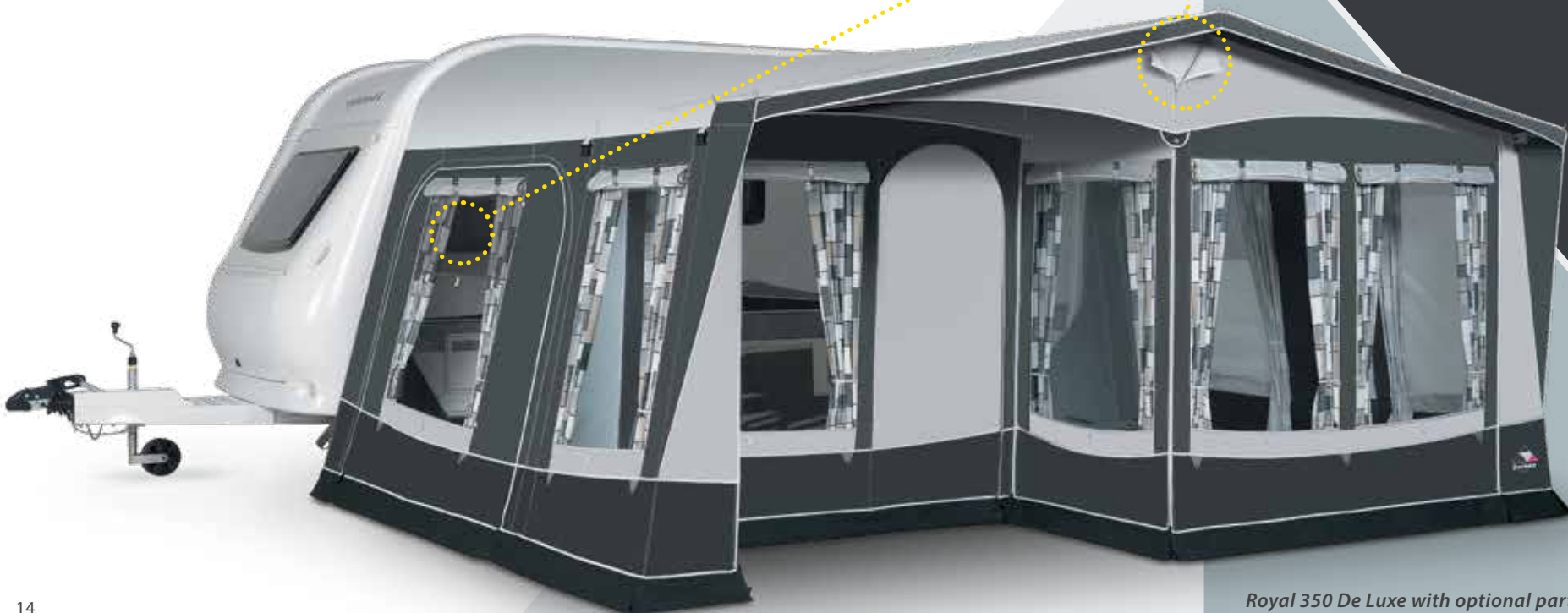

SEASONAL



EASYGRIP



SAFE LOCK SYSTEM



QUICKLOCK PADS INCLUDED

Royal 350 De Luxe with optional partition wall



ROYAL 350 DELUXE

Seasonal

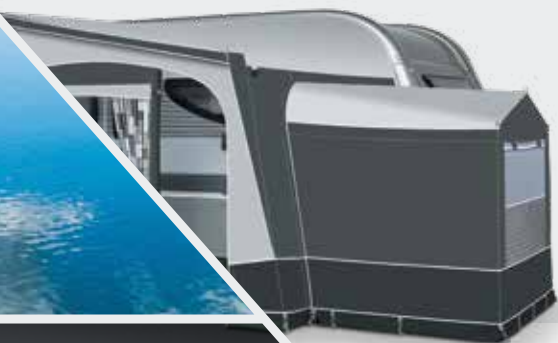

Annex
215 x 130 cm

Optional Extras:

- 2 x SafeLock System Kit
- Partition wall to be used between the two front panels
- Annex
- Annex De Luxe
- Inner tent

(Both annexes feature our double zip system to refit side panel)

- Roof Support poles
- Stormpoles
- Veranda pole
- Starlon carpet
- Palma awning canopy
- Extra front panel for a portal solution

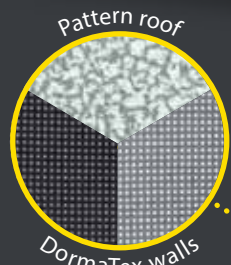

Annex De Luxe
215 x 130 cm



Partition wall (optional) used at right angles to front panels to create the layout as shown in the image



Royal 350 De Luxe

SIZE	CM	ROYAL 350 DLX	EXTRA FRONT PANEL
8	825 - 850	£2322	£329
9	850 - 875	£2410	£336
10	875 - 900	£2528	£343
11	900 - 925	£2589	£357
12	925 - 950	£2662	£366
13	950 - 975	£2780	£375
14	975 - 1000	£2839	£384
15	1000 - 1025	£2927	£398
16	1025 - 1050	£2986	£412
17	1050 - 1075	£3047	£422
18	1075 - 1100	£3120	£434
19	1100 - 1125	£3191	£447
20	1125 - 1150	£3251	£466
21	1150 - 1175	£3311	£484
22	1175 - 1200	£3355	£505

OPTIONAL EXTRAS	
ANNEX	£543
ANNEX DE LUXE (WITH REAR DOOR)	£589
SAFE LOCK SYSTEM (REQUIRES 2 SETS)	£33
INNER TENT	£109
PARTITION WALL	£233

EMBRACE NEW ADVENTURES



DOREMA PORCH AWNINGS

When producing our porch awnings, we incorporate the same quality materials that can be found on our collection of full awnings. The demands of today's and tomorrow's campers are at the forefront of our innovation and design process, while maintaining our passion to enhance space and create an extra dimension to the joy of camping.

'Which porch awning will fit my caravan?'

*This is a common question that we are regularly asked. Our porch awnings are designed to fit along the straight horizontal section of the awning rail on your caravan (**measurement A**). The measurement from the ground to the awning rail, at the top of your caravan, should be 235cm to 250cm (**measurement B**).*



We provide the floor size measurement and the roof width measurement for all of our porch awnings. These measurements will determine whether the sides of the porch awning are sloping or 90 degrees vertical. There are other factors which you may want to consider, for example, the location of vents, lockers, windows, etc. With this information you will be able to make the right choice on the porch awning that best suits your requirements.

DAVOS & OSLO

Winter porch awning

Heavy Duty PVC materials /

Use of internal or external pegging points allow the mudwalls to be positioned inside or outside

SIOEN INDUSTRIES



Technical Data:

Height:	To fit caravans from 235-250 cm
Floor sizes:	Roof Width including canopy:
Size 1: 200 x 200 cm	200 cm + 2 x 20 cm
Size 2: 250 x 200 cm	250 cm + 2 x 20 cm
Size 3: 300 x 200 cm	300 cm + 2 x 20 cm
Size 4: 350 x 200 cm	350 cm + 2 x 20 cm
Standard frame:	
Davos	25 mm steel
Oslo	25 mm steel freestanding

Colour:	
Davos	blue / grey
Oslo	charcoal / grey
Roof and wall material:	PVC coated polyester.
Frontpanel:	
Davos	Can be rolled up.
Oslo	Can be rolled down or zipped out.
Sidepanel:	Both panels are fitted with a door and sewn in rear cushion pads
Combined weight (canvas + standard frame):	
Davos	Size 1 = 28 kg / Size 3 = 31 kg (approx.)
Oslo	Size 1 = 32 kg / Size 4 = 41 kg (approx.)

DAVOS FROM
£589
OSLO FROM
£734

Optional Extras: Davos

- Rail stopper
- Rear leg set



DAVOS

Optional Extras: Oslo

- SafeLock System Kit
- Rail stopper
- Veranda pole
- EasyGrip Upgrade



OSLO

	SIZE	DAVOS	OSLO
1	200 X 200 cm	£589	£734
2	250 X 200 cm	£634	£810
3	300 X 200 cm	£687	£853
4	350 X 200 cm	-	£905
OPTIONAL EXTRAS			
	REAR LEG SET (DAVOS ONLY)	£52	-
	SAFE LOCK SYSTEM KIT (OSLO ONLY)	-	£33



WINTER

OSLO ONLY



SAFE LOCK SYSTEM

DAVOS ONLY



QUICKLOCK PADS INCLUDED



TENCATE
OUTDOOR FABRICS

MISTRAL & MISTRAL XL

The perfect porch for touring holidays

Internal roll up privacy blinds / Simple to erect

PORCH
AWNINGS

FROM
£780

Technical Data:

Height: To fit caravans from 235 - 250 cm

Floor sizes: **Roof Width:**

Mistral: 300 x 240 cm 250 cm

Mistral XL: 360 x 240 cm 310 cm

Frame:

Mistral 25 mm EasyGrip steel

Mistral XL 28 mm EasyGrip steel

Combined weight (canvas + standard frame):

Mistral 16,5 kg

Mistral XL 21 kg

Colour:

Mistral charcoal / grey

Mistral XL charcoal / grey

Roof and wall material: TenCate touring quality coated polyester.

Frontpanel: Zip out panel.

Sidepanels: Fitted doors both on the left and right-hand side, with part fly screen and sewn in rear cushion pads.

Optional Extras:

- SafeLock System Kit
- Rail stopper
- Rear upright legs



Mistral



Mistral XL

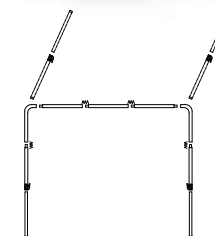

Mistral / Mistral XL frame diagram

PRODUCT	CM	PRICE
MISTRAL	300 x 240 cm	£780
MISTRAL XL	360 x 240 cm	£883

OPTIONAL EXTRAS	
SAFE LOCK SYSTEM KIT	£33
REAR UPRIGHT LEGS (SET OF 2)	£52



TOURING



EASYGRIP



SAFE LOCK SYSTEM

SAFARI

An introduction to quality seasonal porch awnings

Increase space by fitting an additional annex



Technical Data:

Height: To fit caravans from 235 - 250 cm
Floor sizes: 320 x 240 cm
Roof Width: 280 cm
Frame Options: 25 mm EasyGrip steel
 Lightweight Fibertech Plus
Colour: charcoal / grey

Roof and wall material: TenCate All Season coated polyester.
Frontpanel: Can be rolled down or zipped out.
Sidepanels: Both panels are fitted with a door and can be zipped out to attach a Safari annex. Sewn in rear cushion pads on either side.

Combined weight (canvas + frame):
 Steel 29 kg
 FibreTech Plus 25 kg

FROM
£958

Optional Extras:

- SafeLock System Kit
- Rail stopper
- Safari Annex
- Inner tent
- Veranda pole

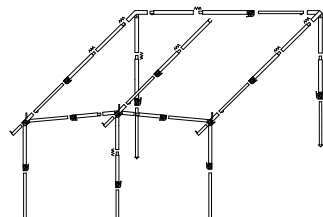

Safari frame diagram

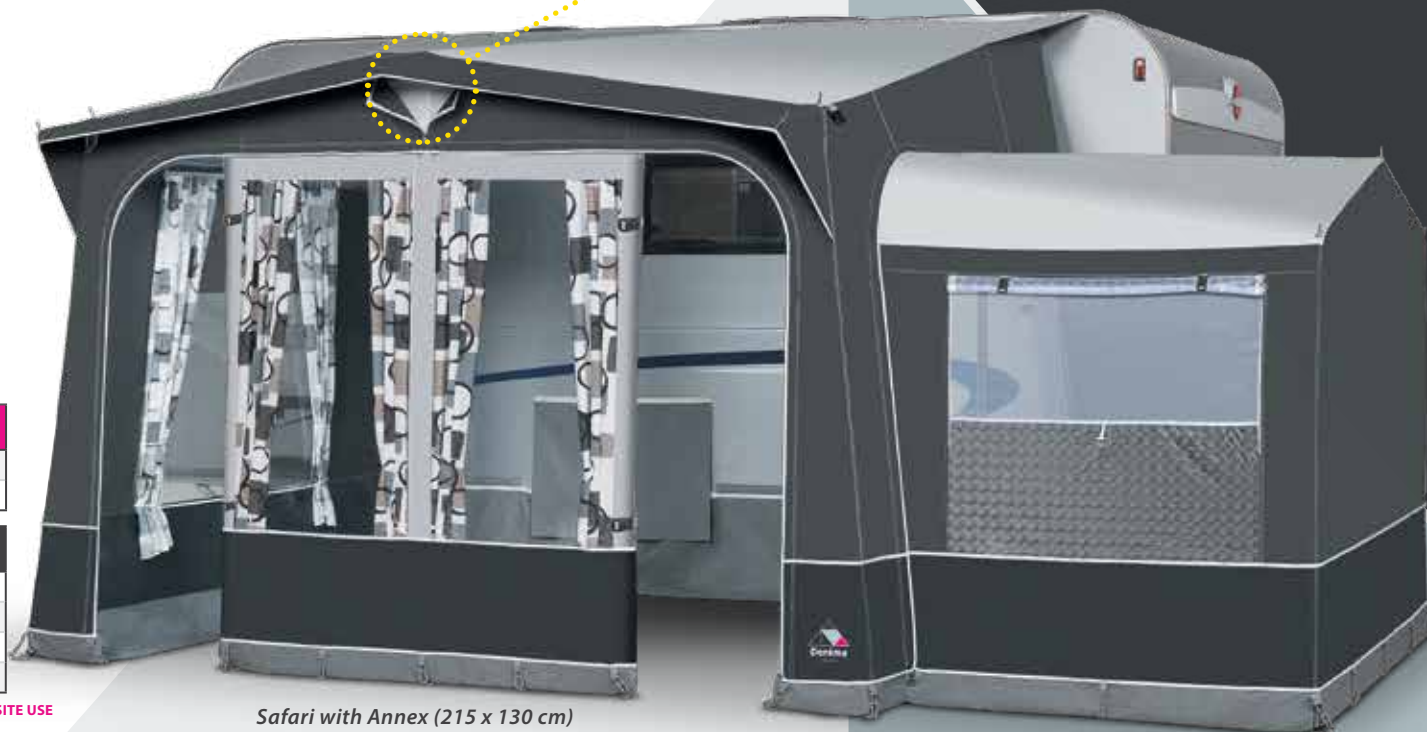
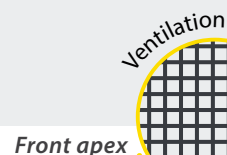

PRODUCT	CM	SAFARI
SAFARI WITH EASYGRIP STEEL FRAME	320 X 240	£958
SAFARI WITH FIBRETECH PLUS FRAME*	320 X 240	£1111

OPTIONAL EXTRAS	
SAFARI ANNEX	£440
ALU FRAME UPGRADE FOR SAFARI ANNEX	£41
SAFELOCK SYSTEM KIT	£33
INNER TENT	£109

*THE FIBRETECH PLUS FRAME OPTION IS NOT SUITABLE FOR SEASONAL SITE USE

Safari with Annex (215 x 130 cm)



TENCATE
OUTDOOR FABRICS

YKK

OMEGA DELUXE

All Season European TenCate Quality porch awning

External zipped privacy blinds fitted as standard /
Use of internal or external pegging points allow the mudwalls to be positioned inside or outside

PORCH
AWNINGS

FROM
£1174

Technical Data:

Height: To fit caravans from 235 - 250 cm
Floor sizes: 340 x 240 cm
Roof Width: 300 cm
Frame Options: 25 mm EasyGrip steel
 Lightweight Fibertech Plus

Colour: charcoal / grey

Omega De Luxe annex features our double zip system to refit side panel

Roof and wall material: TenCate All Season coated polyester.
Frontpanel: Can be rolled down or zipped out.
Sidepanels: Both panels are fitted with a door and can be zipped out to attach an Omega annex. Part fly screen fitted to one side panel. Sewn in rear cushion pads to each side.

Combined weight (canvas + frame):

Steel 30 kg
 FiberTech Plus 26 kg

Optional Extras:

- SafeLock System Kit
- Rail stopper
- Omega De Luxe Annex
- Inner tent
- Veranda pole

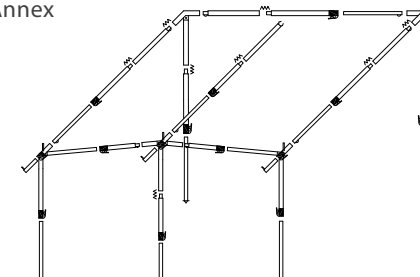

Omega De Luxe frame diagram

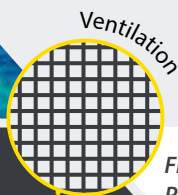

Ventilation

Front apex
Part fly screen to one side panel



SEASONAL



EASYGRIP



SAFE LOCK SYSTEM



Omega De Luxe with Annex (215 x 130 cm)

PRODUCT	CM	OMEGA DE LUXE
OMEGA DE LUXE WITH EASYGRIP STEEL FRAME	340 X 240	£1174
OMEGA DE LUXE WITH FIBRETECH PLUS FRAME*	340 X 240	£1327

OPTIONAL EXTRAS	
OMEGA DE LUXE ANNEX	£468
INNER TENT	£109
SAFELOCK SYSTEM KIT	£33
ALU FRAME UPGRADE FOR OMEGA DE LUXE ANNEX	£41

*THE FIBRETECH PLUS FRAME OPTION IS NOT SUITABLE FOR SEASONAL SITE USE

QUATTRO 225 & 275

All Season European TenCate Quality porch awnings

Dual gradient roof /

Use of internal or external pegging points allow the mudwalls to be positioned inside or outside



Technical Data:

Height: To fit caravans from 235 - 250 cm

Floor sizes: **Roof Width:**

225: 225 x 200 cm 195 cm

275: 275 x 200 cm 245 cm

Colour: charcoal / grey

Frame options:

225 & 275: 25 mm EasyGrip steel
ALU EasyGrip

Roof and wall material: TenCate All Season coated polyester.

Frontpanel: One front panel, can be rolled down or zipped out.

Sidepanels: Both panels are fitted with a door, part fly screen and sewn in rear cushion pads.

Combined weight (canvas + frame):

Quattro 225 with steel frame = 27 kg (approx.)

Quattro 225 with ALU frame = 20 kg (approx.)

Quattro 275 with steel frame = 30 kg (approx.)

Quattro 275 with ALU frame = 22 kg (approx.)

FROM
£703

225 & 275 Optional Extras:

- SafeLock System Kit
- Rail stopper
- Veranda pole

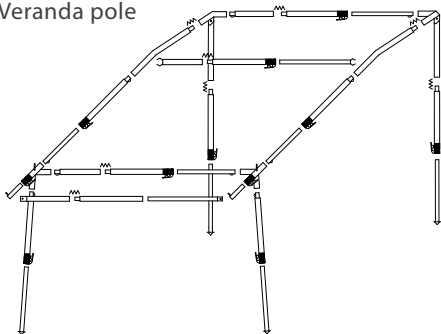

Quattro 225 & 275 frame diagram

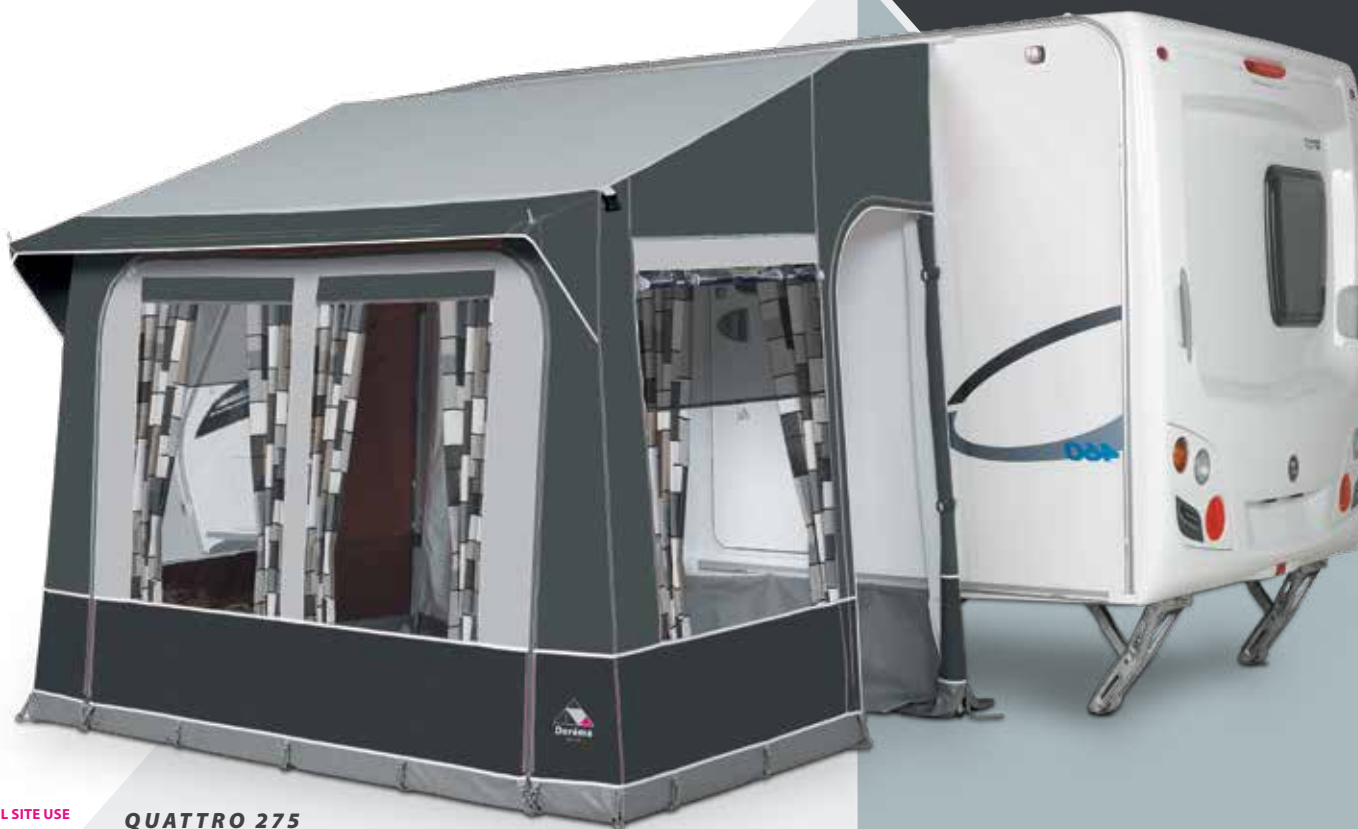

SEASONAL



EASYGRIP



SAFE LOCK SYSTEM

PRODUCT	QUATTRO 225 & 275
QUATTRO 225 WITH EASYGRIP STEEL FRAME	£703
QUATTRO 225 WITH EASYGRIP ALU FRAME*	£781
OPTIONAL EXTRAS	
QUATTRO 275 WITH EASYGRIP STEEL FRAME	£780
QUATTRO 275 WITH EASYGRIP ALU FRAME*	£858
SAFELOCK SYSTEM KIT	£33

*THE LIGHTWEIGHT FRAME OPTIONS ARE NOT SUITABLE FOR SEASONAL SITE USE

QUATTRO 275



QUATTRO 380 & 430

The ultimate stability for quality porch awnings

Dual gradient roof / Use of internal or external pegging points allow the mudwalls to be positioned inside or outside

FROM
£1174

Technical Data:

Height: To fit caravans from 235 - 250 cm

Floor sizes:	Roof Width:
380: width 380 x depth 240 cm	340 cm
430: width 430 x depth 240 cm	390 cm

Colour: charcoal / grey

Frame options:

380 & 430:	25 mm EasyGrip steel
	28 mm EasyGrip steel

Roof and wall material: TenCate All Season coated polyester.

Frontpanel: Can be rolled down or zipped out.

380 & 430 Two front panels with central zip.

Sidepanels: Both panels are fitted with a door, part fly screen and sewn in rear cushion pads.

Combined weight (canvas + frame):

Quattro 380 with steel frame = 36 kg (approx.)

Quattro 430 with steel frame = 39 kg (approx.)

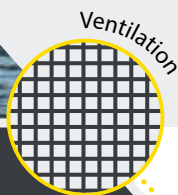

Part fly screen to both side panels
Under canopy



SEASONAL



EASYGRIP



SAFE LOCK SYSTEM

380 & 430 Optional Extras:

- SafeLock System Kit
- Rail stopper
- Winter package for Quattro 380 & 430 (2 extra roof poles and 3 extra stormpoles)

- Roof lining for Quattro 380 or 430
- Veranda pole

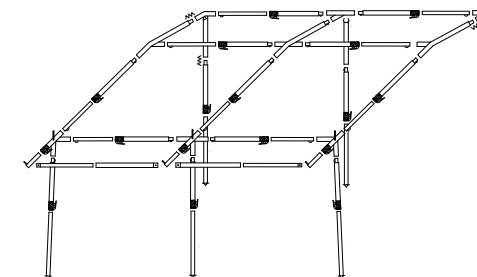

Quattro380 & 430 frame diagram

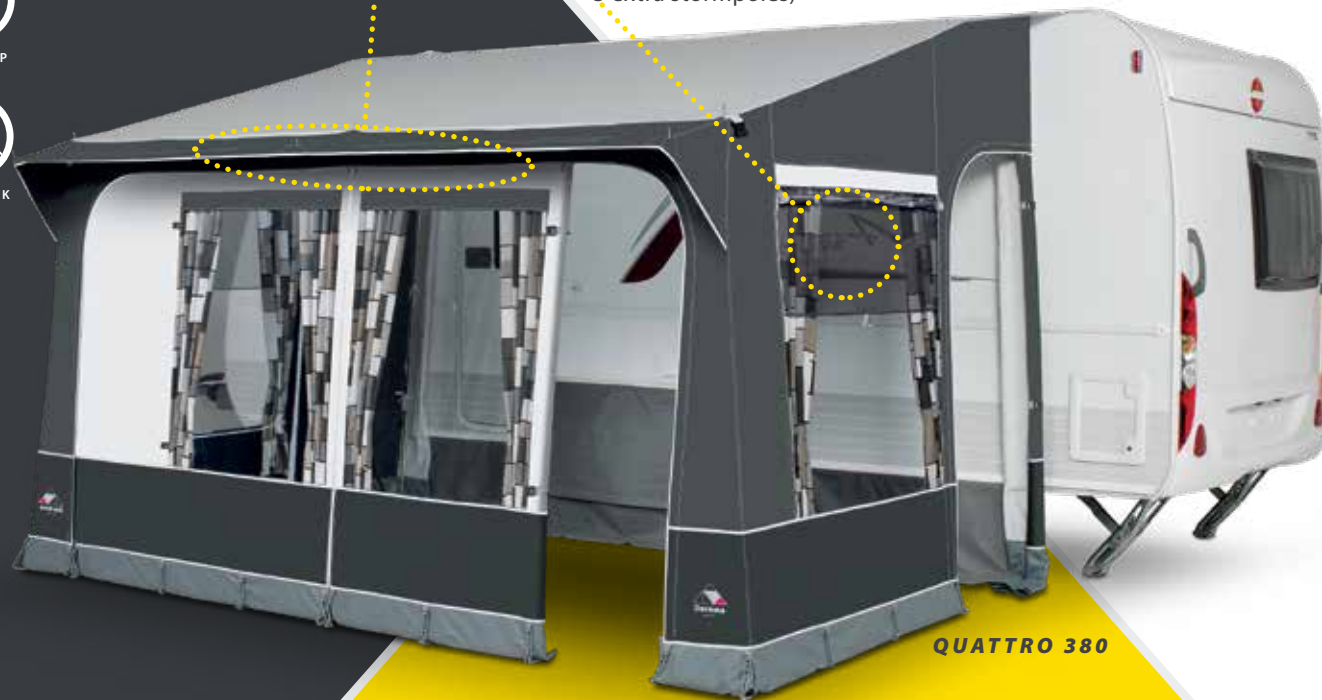

QUATTRO 380

PRODUCT	QUATTRO 380 & 430
QUATTRO 380 WITH 25 mm EASYGRIP STEEL FRAME	£1174
QUATTRO 380 WITH 28 mm EASYGRIP STEEL FRAME	£1257

QUATTRO 430 WITH 25 mm EASYGRIP STEEL FRAME	£1265
QUATTRO 430 WITH 28 mm EASYGRIP STEEL FRAME	£1348

380 & 430 OPTIONAL EXTRAS	
WINTER PACKAGE 25 mm EASYGRIP STEEL	£130
WINTER PACKAGE 28 mm EASYGRIP STEEL	£148
ROOF LINING QUATTRO 380	£102
ROOF LINING QUATTRO 430	£110
SAFELOCK SYSTEM KIT	£33

***THOUGH YOU ARE FAR FROM HOME
YOU ALWAYS FEEL RIGHT AT HOME***



AIR AWNING TECHNOLOGY HAS PROVEN TO BE A HUGELY POPULAR CHOICE WITH TODAY'S CAMPERS.

We have embraced this and combined our recognised quality with the air technology to create an extensive range of strong and durable inflatable awnings. Our designs compliment the traditional with the modern.

Our EAF (Easy Air Frame) System, with its single inflation point and multi-valve deflation points, make our air frames very simple and fast to use.

When inflated, the isolation valves provide stability, reliability and easy maintenance.

Our innovations and designs enhance space and creates an extra dimension to the joy of modern-day camping.

DAYTONA AIR

Double your living space with ease

The pioneer of traditional shaped full air awnings / Easy Air Frame System (EAF) / Single Inflation Point / Isolation Valves

Technical Data:

Depth:	240 cm
Sizes:	775 - 1125
Colour:	charcoal / grey
Frame:	Easy Air Frame System (EAF) Recommended air pressure 8-10 psi

Lightweight canopy poles supplied as standard on all sizes.

Material Roof: TenCate All Season quality coated polyester.
Material Sides: TenCate All Season quality coated polyester.
Frontpanels: Both front panels are fitted with a door and can be rolled down or zipped out.
Sidepanels: Both panels are fitted with a door, part fly screen and can be zipped out to attach a Daytona Air annex.

Total weight:
 Size 6 = 31kg / Size 19 = 46 kg (approx.)

FROM
£1474

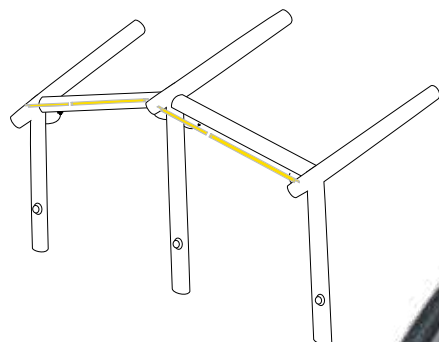

Daytona Air main frame system
 (additional roof support and storm tubes are supplied as standard on sizes 9-19)

Ventilation

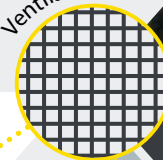

Dual apex
 Part fly screen to both side panels



SEASONAL



EASY AIR
 FRAME



SAFE LOCK
 SYSTEM



HAND PUMP
 INCLUDED



Triple SafeLock System Kit
(only for full Air awnings)

ONLY £40



Optional Extras:

- Triple SafeLock System Kit
- Rechargeable Cordless Electric Pump
- Daytona Air annex
- Inner tent
- Starlon carpet
- Palma awning canopy



Daytona Air Annex
210 x 140 cm

EAF - Easy Air Frame System

- External single inflation point
- External multi-valve for rapid deflation
- Isolation valves
- Connecting tubes fitted with a reinforced coil
- Reinforced twin walled inner tube jacket
- Seamless tubular TPU inner tube with high frequency weld to each end
- EAF system supplied with a high volume hand pump

Rechargeable Cordless Electric Pump

ONLY £249



SIZE	CM	DAYTONA AIR
6	775 – 800	£1474
7	800 – 825	£1561
8	825 – 850	£1620
9	850 – 875	£1765
10	875 – 900	£1915
11	900 – 925	£2002
12	925 – 950	£2106
13	950 – 975	£2206
14	975 – 1000	£2297
15	1000 – 1025	£2429
16	1025 – 1050	£2519
17	1050 – 1075	£2592
18	1075 – 1100	£2697
19	1100 – 1125	£2797

OPTIONAL EXTRAS

DAYTONA AIR ANNEX	£589
INNER TENT	£109
TRIPLE SAFELOCK SYSTEM KIT	£40
RECHARGEABLE CORDLESS ELECTRIC PUMP	£249

Air awnings need to be monitored regularly and may require a top up of air to maintain stability.

LUXOR AIR 280

LATEST UNIQUE MODERN DESIGN FULL AIR AWNING 280CM DEEP

The Luxor Air 280 is an exciting addition to our superb collection of full air awnings. Specially developed, this luxurious design is enhanced by the generous space that the 280cm depth provides.

Incorporating our Easy Air Frame system, the Luxor Air 280 is rapidly inflated from a single external inflation point. Each air tube section can then be isolated for easy maintenance and to preserve the air pressure within each individual section of the main air frame.

The unique shape allows maximum light to enter the awning adding an extra dimension to your comfort and to the joy of seasonal camping.



FROM
£2550



SEASONAL



EASY AIR
FRAME



SAFE LOCK
SYSTEM



HAND PUMP
INCLUDED



LUXOR AIR 280

Seasonal

Technical Data:

Depth: 280 cm
Sizes: 850 - 1125
Colour: charcoal / grey
Frame: Easy Air Frame System (EAF)
 Recommended air pressure 8-10 psi

Lightweight canopy poles supplied as standard on all sizes..

Material Roof: TenCate All Season coated polyester, printed pattern design on the inside.

Material Sides: DormaTex TenCate All Season coated polyester.

Frontpanels: Both front panels are fitted with a door and can be rolled down or zipped out.

Sidepanels: Both panels are fitted with a full fly screen and can be zipped out to attach a Luxor Air 280 annex. A window / door panel to both front corners.

Total weight:

Size 9 = 45 kg / Size 19 = 60 kg (approx.)

Optional Extras:

- 2 x Triple SafeLock System Kit
- Rechargeable Cordless Electric Pump
- Luxor Air annex
- Inner tent
- Starlon carpet

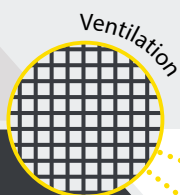

*Dual apex
Full fly screen to both sides panels*



Luxor Air 280 with Annex 150 x 220 cm

SIZE	CM	LUXOR AIR 280
9	850 - 875	£2550
10	875 - 900	£2728
11	900 - 925	£2814
12	925 - 950	£2929
13	950 - 975	£3042
14	975 - 1000	£3156
15	1000 - 1025	£3357
16	1025 - 1050	£3471
17	1050 - 1075	£3560
18	1075 - 1100	£3647
19	1100 - 1125	£3736

OPTIONAL EXTRAS	
LUXOR AIR ANNEX	£783
INNER TENT	£127
TRIPLE SAFELOCK SYSTEM KIT	£40
RECHARGEABLE CORDLESS ELECTRIC PUMP	£249

Air awnings need to be monitored regularly and may require a top up of air to maintain stability.

HORIZON AIR DELUXE

New for 2021! The ultimate seasonal full air awning, now with fitted zipped privacy blinds

Easy Air Frame System / Interchangeable front panels with zipped arched doorway / Fitted with twin mud walls

Technical Data:

Depth: 240 cm
Sizes: 775 - 1200
Colour: charcoal / grey
Frame: Easy Air Frame System (EAF)
 Recommended air pressure 8-10 psi

Privacy Blinds: External zipped privacy blinds fitted to all windows.

Lightweight canopy poles supplied as standard on all sizes.

Material Roof: TenCate All Season coated polyester, printed pattern design on the inside.

Material Sides: DormaTex TenCate All Season coated polyester.

Frontpanels: These panels can be rolled down or zipped out. Both panels are interchangeable, allowing the fitted zipped arched doorway to have two optional layouts.

Sidepanels: Both panels are fitted with a door, full fly screen and can be zipped out to attach a Horizon Air Annex.

Total weight:

Size 6 = 37 kg / Size 22 = 65 kg (approx.)

FROM
£2360

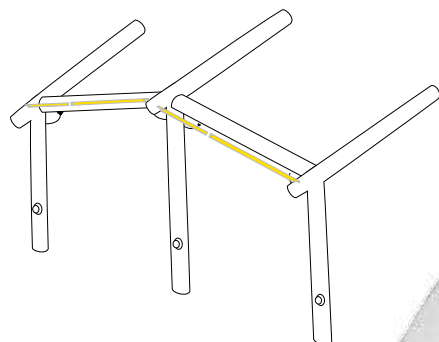

Horizon Air main frame system
 (additional roof support and storm tubes are supplied as standard on sizes 6-22)

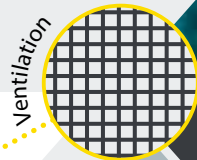

Ventilation

Dual apex
 Full fly screen to both side panels



SEASONAL



EASY AIR FRAME



SAFE LOCK SYSTEM



HAND PUMP INCLUDED

Horizon Air De Luxe with veranda effect



TENCATE
OUTDOOR FABRICS

YKK

HORIZON AIR DELUXE

Seasonal

AIR
AWNINGS

Optional Extras:

- Triple SafeLock System Kit
- Rechargeable Cordless Electric Pump
- Horizon Air annex
- Inner tent
- Veranda pole
- Starlon carpet
- Palma awining canopy



Horizon Air De Luxe with door panel rolled up



Horizon Air De Luxe with Annex 210 x 140 cm

SIZE	CM	HORIZON DLX
6	775 - 800	£2360
7	800 - 825	£2443
8	825 - 850	£2525
9	850 - 875	£2606
10	875 - 900	£2775
11	900 - 925	£2855
12	925 - 950	£2963
13	950 - 975	£3069
14	975 - 1000	£3174
15	1000 - 1025	£3363
16	1025 - 1050	£3469
17	1050 - 1075	£3553
18	1075 - 1100	£3632
19	1100 - 1125	£3716
20	1125 - 1150	£3799
21	1150 - 1175	£3883
22	1175 - 1200	£3953

OPTIONAL EXTRAS	
HORIZON AIR ANNEX	£762
INNER TENT	£109
TRIPLE SAFELOCK SYSTEM KIT	£40
RECHARGEABLE CORDLESS ELECTRIC PUMP	£249

Air awnings need to be monitored regularly and may require a top up of air to maintain stability.

MAGNUM AIRFORCE ALLSEASON

The latest generation of versatile porch awnings

External single inflation point / Flexible layout combinations to suit your desired living space / Free standing left and right AddExes

Technical Data:

Height: To fit caravans from 235 - 250 cm
Floor sizes: **Roof Width:**
 260: 260 x 280 cm 260 cm
 390: 390 x 280 cm 390 cm
 AddEx: 270 x 280 cm n/a
Colour: charcoal / grey
Frame: Easy Air Frame System (EAF)
 Recommended air pressure 8-10 psi

Privacy Blinds: Internal zipped privacy blinds fitted to all windows.

Rear upright poles and sewn in rear cushion pads supplied as standard.

Material Roof: TenCate All Season coated polyester, printed pattern design on the inside.

Material Sides: DormaTex TenCate All Season coated polyester.

Frontpanels: All panels can be rolled down or zipped out.

Sidepanels: Both panels are fitted with a door and can be rolled back to open up the side.

Total weight:

260	27 kg (approx.)
390	37 kg (approx.)
AddEx	13 kg (approx.)

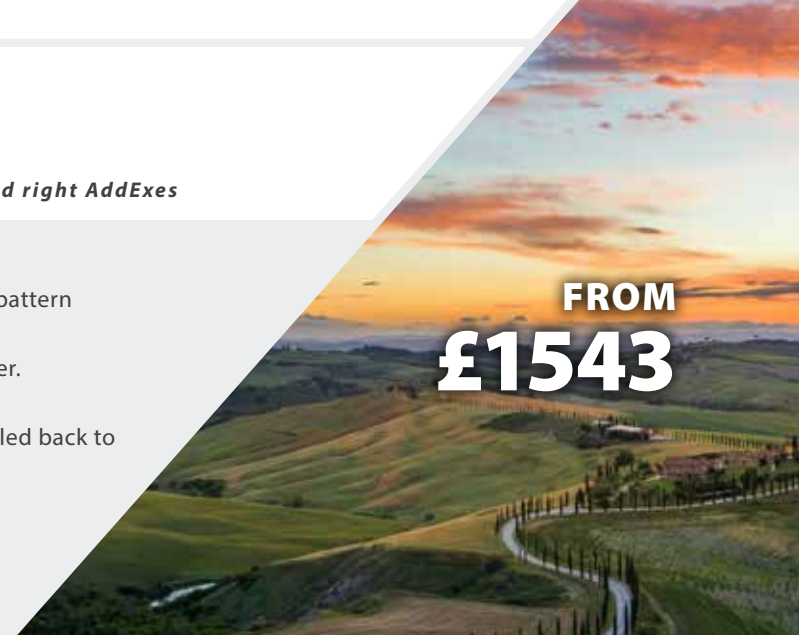

FROM
£1543

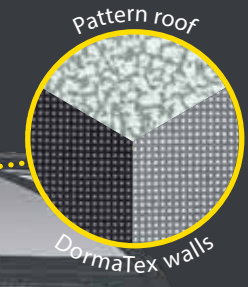

HAND PUMP INCLUDED

Magnum AirForce 390 All Season with right AddEx



MAGNUM AIRFORCE ALLSEASON

Seasonal

Optional Extras:

- Rail stopper
- Left / Right AddEx
- Inner tent
- Roof lining
- Veranda Air tube
- Rechargeable Cordless Electric Pump
- Sun canopy

AddEx rear panel has a window with fitted internal zipped privacy blind

Bottom of AddEx rear panel can be unzipped for easy access to storage lockers on caravan.



Magnum Air Force 260 All Season with Sun Canopy and Left AddEx with panels zipped out

Ventilation

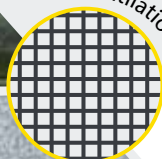

Top rear corners
Covered fly screen on both side doors



Magnum AirForce 390 All Season

AddExes are fully sealed to the side of the porch awning by an all round covered zip. Please note that the AddExes do not fit into the caravan awning rail.

PRODUCT	CM	MAGNUM AF AS
MAGNUM AIR FORCE 260 AS	260 X 280	£1543
MAGNUM AIR FORCE 390 AS	390 X 280	£1841

OPTIONAL EXTRAS	
ADDEX LEFT OR RIGHT	£920
ADDEX INNER TENT LEFT / RIGHT	£67
ROOF LINING ADDEX LEFT/RIGHT	£34
260 SUN CANOPY	£132
390 SUN CANOPY	£173
260/390 INNER TENT	£72
260 ROOF LINING	£37
390 ROOF LINING	£56
RECHARGEABLE CORDLESS ELECTRIC PUMP	£249

Air awnings need to be monitored regularly and may require a top up of air to maintain stability.

DOREMA SUN CANOPY

Our experience spreads across many years of producing awnings for campers around the world.

We recognise that for some just a simple or elegant looking sunshade is all that is required to appreciate the vast open spaces of the great outdoors.

Our collection of Sun Canopies offers you the ability to relax in freedom, creating an extra dimension to the joy of simple camping.

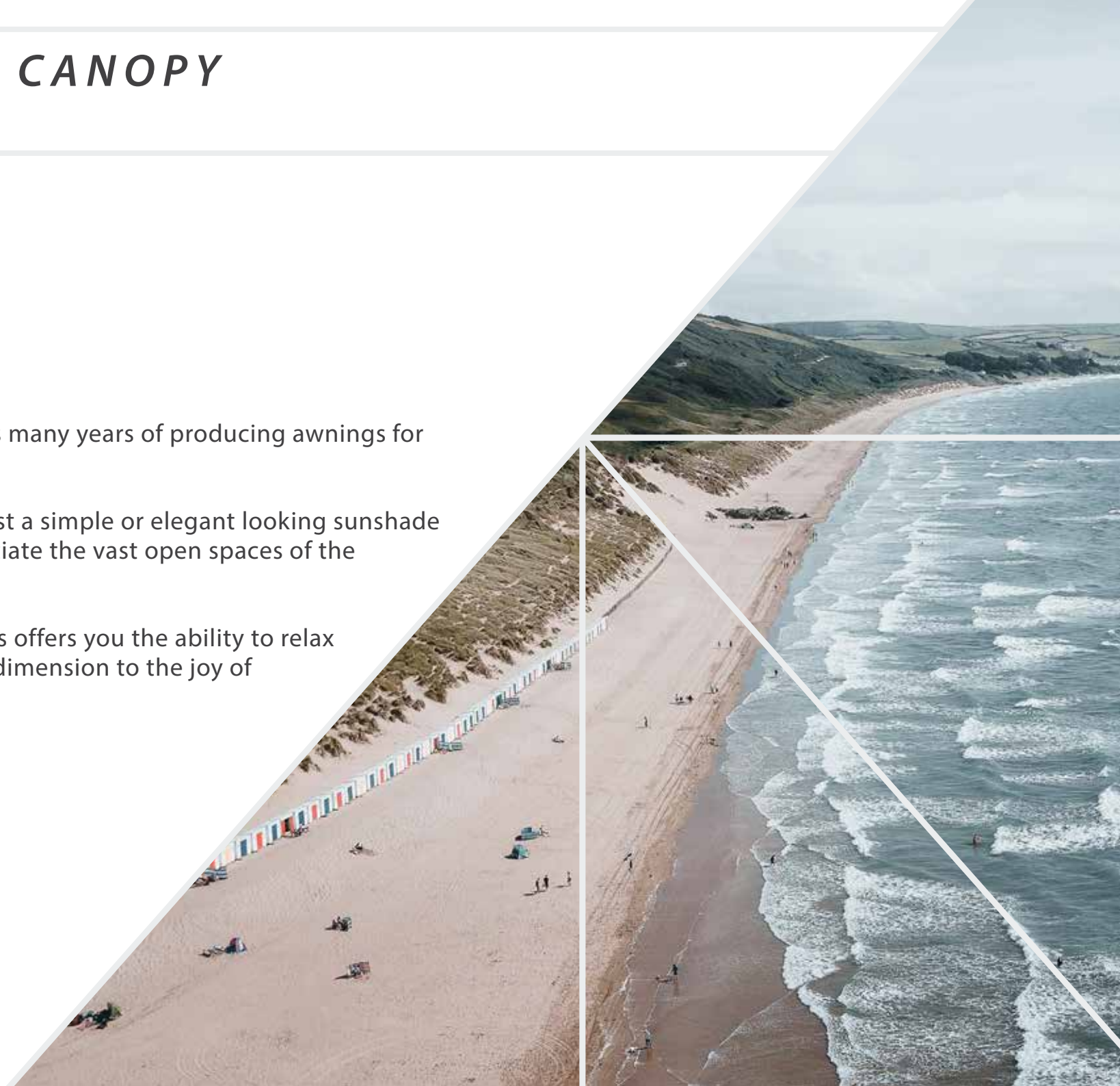



UNI, MONACO & NICE SUNCANOPIES

A simple collections of sunshades

Manufactured with lightweight European materials / Optional Frame Upgrade

SUN CANOPIES

FROM
£138

Technical Data:

CANOPY UNI

Roof Sizes:

Size: 1: Width 240 x Depth 220 cm

Size: 2: Width 300 x Depth 220 cm

Colour: grey

Material: Coated polyester

Combined weight (canvas + frame):

Steel = 5 kg

ALU = 4 kg

CANOPY MONACO

Depth: 220 cm

Sizes: 660 - 1020 cm

Colour: grey

Material: Coated polyester

Combined weight (canvas + frame):

Steel Frame Size 2 = 12 kg / Size 10 = 14 kg

ALU Frame Size 2 = 10 kg / Size 10 = 12 kg

CANOPY NICE

Depth: 220 cm

Sizes: 660 - 1020 cm

Colour: grey

Material: Coated polyester

Combined weight (canvas + frame):

Steel Frame Size 2 = 13 kg / Size 10 = 15 kg

ALU Frame Size 2 = 11 kg / Size 10 = 13 kg

Optional extra:

- EasyGrip Alloy Upgrade

Optional extra:

- EasyGrip Alloy Upgrade

Optional extra:

- EasyGrip Alloy Upgrade



TOURING



EASYGRIP

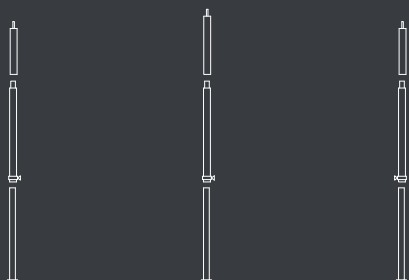

Uni, Monaco & Nice upright poles
supplied as standard

SIZE	SIZE	UNI
1	240 X 220 cm	£138
2	300 X 220 cm	£158
EASYGRIP ALLOY UPGRADE		£13

SIZE	A-MEASUREMENT	MONACO
2	660 - 700	£183
3	700 - 740	£191
4	740 - 780	£205
5	780 - 820	£222
6	820 - 860	£236
7	860 - 900	£248
8	900 - 940	£263
9	940 - 980	£281
10	980 - 1020	£293
EASYGRIP ALLOY UPGRADE		£13

SIZE	A-MEASUREMENT	NICE
2	660 - 700	£228
3	700 - 740	£237
4	740 - 780	£248
5	780 - 820	£262
6	820 - 860	£275
7	860 - 900	£292
8	900 - 940	£305
9	940 - 980	£320
10	980 - 1020	£334
EASYGRIP ALLOY UPGRADE		£13

Sun canopies are for sunshade use only and should not be used overnight or left unattended.

PANORAMA SUNCANOOPY

The choice is yours

Arched zip out side panels with 5 colour choices / 240 cm depth / Two frame options / Fitted with SafeLock System



Technical Data:

Depth: 240 cm
 Sizes: 770 - 1025 cm
 Colour: 5 colour options (see images below)
 Frame Options: 22 mm Steel
 25 mm ALU

Material Roof & Sides: TenCate lightweight coated polyester.

Combined weight (canvas + frame):

Steel Frame Size 4 = 19 kg / Size 15 = 24 kg
 ALU Frame Size 4 = 16 kg / Size 15 = 21 kg

Optional Extras:

- SafeLock System Kit

FROM
£697



Blue / grey

Red / grey

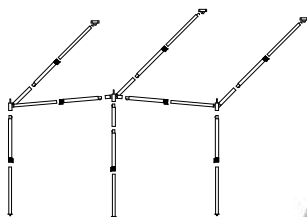

Panorama frame system

SIZE	CM	STEEL FRAME	ALU FRAME
5	750 - 775	£697	£743
6	775 - 800	£708	£754
7	800 - 825	£719	£765
8	825 - 850	£730	£776
9	850 - 875	£742	£788
10	875 - 900	£760	£805
11	900 - 925	£773	£818
12	925 - 950	£783	£828
13	950 - 975	£792	£837
14	975 - 1000	£802	£847
15	1000 - 1025	£811	£856

OPTIONAL EXTRAS	
SAFELock SYSTEM KIT	£33



Charcoal / grey



TOURING



SAFE LOCK SYSTEM



QUICKLOCK PADS INCLUDED



EASYGRIP

Sun canopies are for sunshade use only and should not be used overnight or left unattended.



TENCATE
OUTDOOR FABRICS

MONDIAL SUNCANOOPY

Curved and shaped in all the right places

Zip Out Side panels / Optional Sun Wings / 240cm depth / Fitted with SafeLock System

SUN
CANOPIES

FROM
£879

Technical Data:

Depth: 240 cm
 Sizes: 850 - 1050 cm
 Colour: charcoal / grey
 Standard Frame: 28 mm EasyGrip steel

Material Roof & Sides: TenCate All Season coated polyester
Sidepanels: Both panels can be zipped out

Combined weight (canvas + frame):

Steel Frame Size 9 = 24 kg / Size 16 = 39 kg
 ALU Frame Size 9 = 17 kg / Size 16 = 26 kg
 Sun Wings 2 kg each

Optional Extras:

- SafeLock System Kit
- Sun Wings



Mondial Sun Canopy
(with central leg removed)

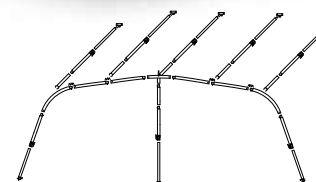

Mondial frame system

SIZE	CM	28 MM EASYGRIP STEEL
9	850 - 875	£879
10	875 - 900	£902
11	900 - 925	£912
12	925 - 950	£929
13	950 - 975	£940
14	975 - 1000	£960
15	1000 - 1025	£974
16	1025 - 1050	£989

OPTIONAL EXTRAS

SAFELock SYSTEM KIT	£33
SUN WINGS (SET OF 2)	£136

Sun canopies are for sunshade use only and should not be used overnight or left unattended.

Zipped sleeve to retain the front poles of the main frame against the canvas of the sun canopy.



TOURING



EASYGRIP



SAFE LOCK SYSTEM



QUICKLOCK PADS INCLUDED



Mondial Sun Canopy with Sun Wings
(with central leg removed)

PALMA AWNING CANOPY

The perfect extension to your awning

Compatible with a selection of Dorema full awnings / Fast and simple to attach to the awning / Two frame options



Technical Data:

Depth: 240 cm
Sizes: 5-22 (charcoal / grey)
 5-19 (blue / grey)

Palma Awning Canopy needs to be ordered in the same size as your awning.

Figure of 8 profile supplied as standard to attach canopy onto the awning.

Colour: blue / grey
 charcoal / grey
Frame Options: 22 mm Steel
 25 mm ALU

Material Roof & Sides: TenCate lightweight coated polyester.

Side Panels: Side panels are tied directly to the main frame.

Combined weight (canvas + frame):

Steel Frame Size 5 = 15 kg / Size 22 = 20 kg
 ALU Frame Size 5 = 10 kg / Size 22 = 15 kg
 Side Panels 3 kg each

FROM
£327



Palma Awning Canopy with side panel

Optional Extras:

- SafeLock Universal System
- SafeLock System Kit
- Side panel



TOURING



EASYGRIP

SIZE	CM	22 MM STEEL	25 MM ALU
5	750 - 775	£327	£373
6	775 - 800	£336	£382
7	800 - 825	£343	£389
8	825 - 850	£352	£398
9	850 - 875	£366	£412
10	875 - 900	£388	£433
11	900 - 925	£398	£443
12	925 - 950	£412	£457
13	950 - 975	£426	£471
14	975 - 1000	£434	£479
15	1000 - 1025	£443	£488
16	1025 - 1050	£461	£506
17	1050 - 1075	£472	£517
18	1075 - 1100	£483	£528
19	1100 - 1125	£493	£538
20	1125 - 1150	£511	£556
21	1150 - 1175	£514	£559
22	1175 - 1200	£530	£575

OPTIONAL EXTRAS	
SIDE PANEL (PER SIDE)	£93
SAFELOCK UNIVERSAL SYSTEM	£9
SAFE LOCK SYSTEM KIT	£33

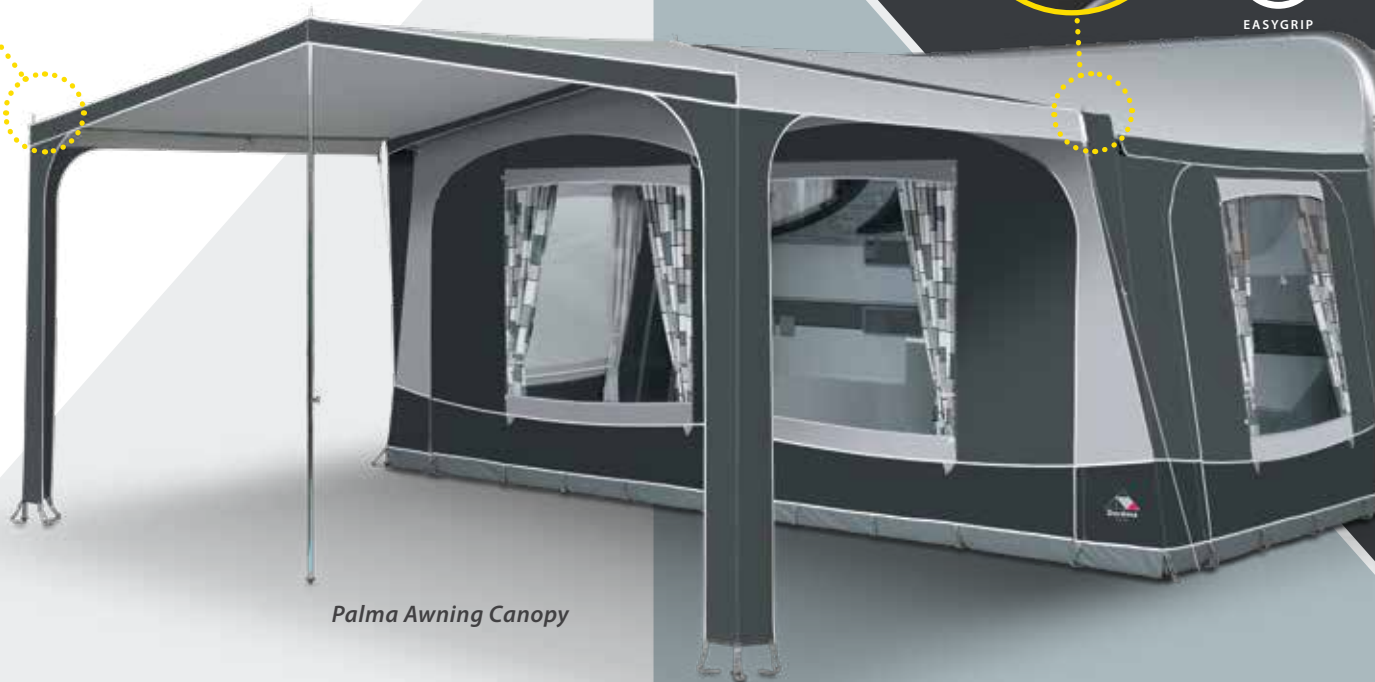

Palma Awning Canopy

Sun canopies are for sunshade use only and should not be used overnight or left unattended.

STARLON CARPET, FRAMES & ACCESSORIES

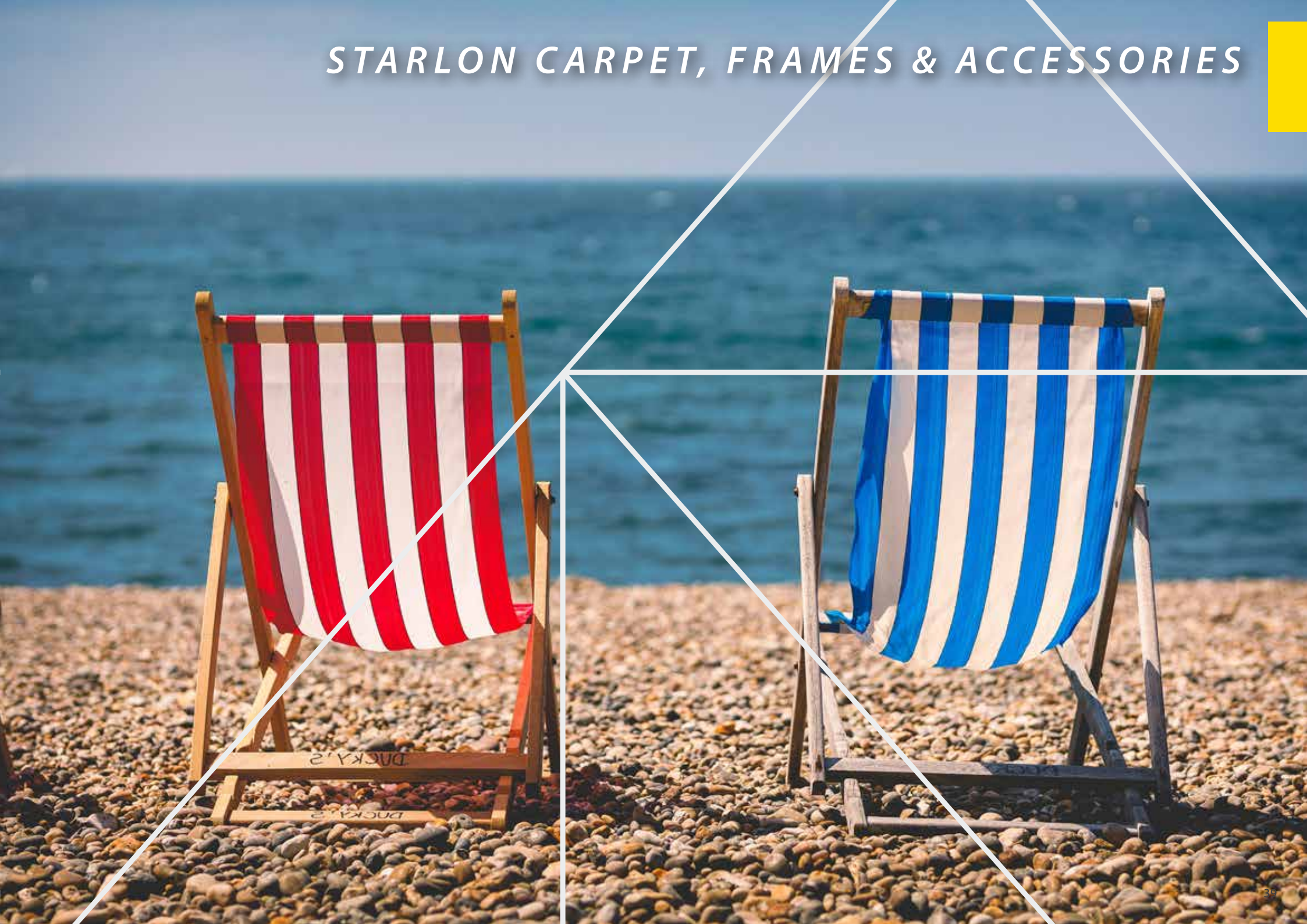

STARLON® AWNING CARPET

Heavy Duty , strong & durable

Dorema has developed this user friendly carpet to ensure the optimal compatibility with your new awning. Starlon is produced in two complimentary colours: Grey and Blue.

This quality carpet is hardwearing, making it suitable for weekend campers and the more enthusiastic seasonal campers. The texture is soft and comfortable especially when the little ones are running around in their bare feet.

Accidental stains such as coffee or red wine are easily removed by using a damp cloth. The construction of the weave allows the Starlon Awning Carpet to breathe making it friendly to the ground beneath.

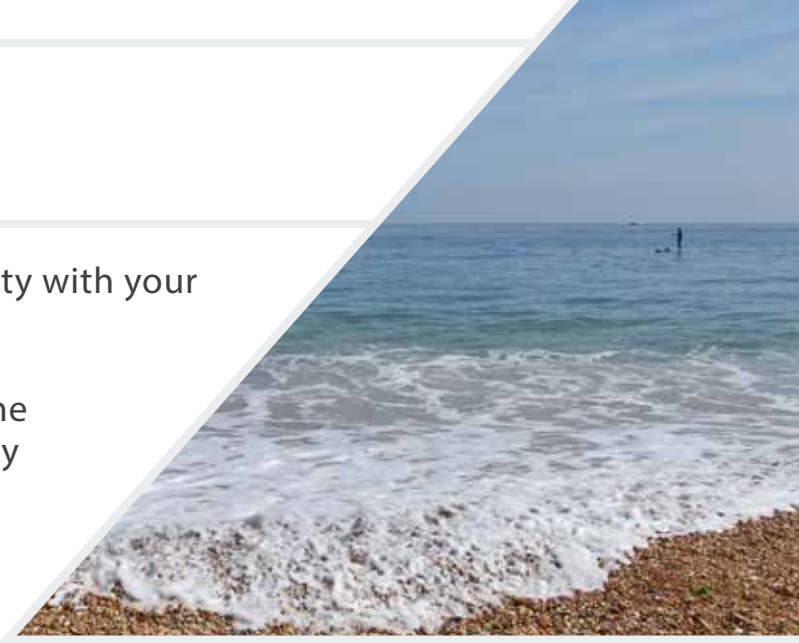

WHICH AWNING CARPET SIZE DO I NEED? *	AWNING SIZE	CARPET SIZE
	4-5-6	400 cm
	7-8-9-10	500 cm
	11-12-13-14	600 cm
	15-16-17-18-19	700 cm
	20-21-22	800 cm

DEPTH 250 CM		DEPTH 280 CM	
250 x 400	£87	280 x 400	£98
250 x 500	£107	280 x 500	£125
250 x 600	£130	280 x 600	£145
250 x 700	£152	280 x 700	£174
250 x 800*	£179	280 x 800*	£205

DEPTH 300 CM		DEPTH 350 CM	
300 x 400	£107	350 x 400*	£145
300 x 500	£136	350 x 500*	£184
300 x 600	£158	350 x 600*	£224
300 x 700	£184	350 x 700*	£263
300 x 800*	£217	350 x 800*	£307

FROM
£87

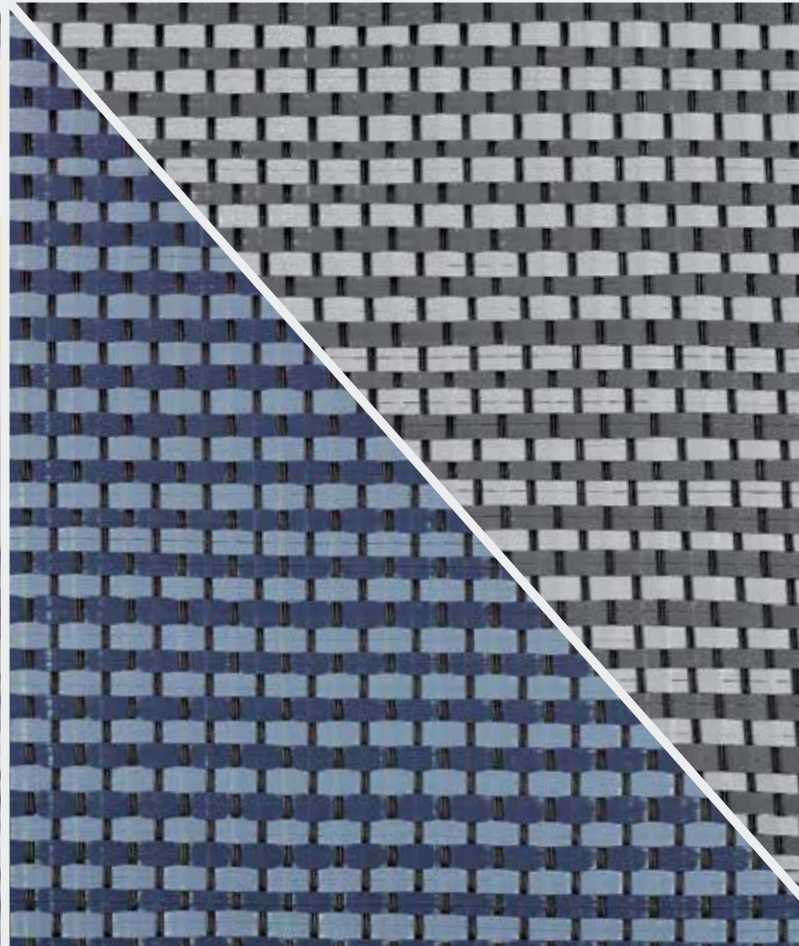

*AVAILABLE ONLY IN GREY / CHARCOAL

FRAMES & ACCESSORIES

STEEL & FIBRETECH PLUS FRAMES

FOR MODELS	SIZE	EASYGRIP STEEL 25mm	EASYGRIP STEEL 28mm	FIBRETECH PLUS
DAYTONA 240, GARDA 240, MULTI NOVA	4 - 9	£161	£219	£293
DAYTONA 240, GARDA 240, MULTI NOVA	10 - 14	£191	£247	£388
DAYTONA 240, GARDA 240, MULTI NOVA	15 - 17	£219	£296	£457
DAYTONA 240, GARDA 240, MULTI NOVA	18 - 19	£219	£296	£465
GARDA XL270, DAYTONA XL270, DAYTONA XL300	4 - 9	£185	£243	£293
GARDA XL270, DAYTONA XL270, DAYTONA XL300	10 - 14	£228	£284	£388
GARDA XL270, DAYTONA XL270, DAYTONA XL300	15 - 17	£262	£339	£457
GARDA XL270, DAYTONA XL270, DAYTONA XL300	18 - 19	£270	£347	£465
EMERALD 270, PRESIDENT 250, XL280, XL300	8 - 9	-	£262	£373
EMERALD 270, PRESIDENT 250, XL280, XL300	10 - 14	-	£316	£424
EMERALD 270, PRESIDENT 250, XL280, XL300	15 - 17	-	£369	£493
EMERALD 270, PRESIDENT 250, XL280, XL300	18 - 19	-	£378	£503
ROYAL 350 DE LUXE	8 - 9	-	£440	-
ROYAL 350 DE LUXE	10 - 12	-	£501	-
ROYAL 350 DE LUXE	13 - 17	-	£575	-
ROYAL 350 DE LUXE	18 - 22	-	£589	-
ONYX 270	9 - 10	-	£472	-
ONYX 270	11 - 12	-	£503	-
ONYX 270	13 - 14	-	£530	-
ONYX 270	15 - 16	-	£570	-

CURTAIN DESIGNS

The awnings can only be supplied with the curtains as illustrated in the brochure.



8159

3615

7009

3623

7020

3236

3237

Please contact your local dealer for more details and prices.

ACCESSORIES

QUICK LOCK PAD, SET OF 3
SAFELOCK SYSTEM KIT SET OF 2
SAFELOCK SYSTEM KIT SET OF 3 (FULL AIR AWNINGS ONLY)
SAFELOCK UNIVERSAL KIT SET OF 2
INNER TENT ANNEX UNIVERSAL
LADDER STRAPS, PER SET OF TEN
EASYGRIP CLAMP: 22, 25 OR 28 MM, PER 4 INC. HEX KEY
RAIL STOPPER TO SECURE PORCH AWNINGS & CANOPIES IN THE RAIL
TEAR-AID A REPAIR SET FOR TEN CATE COATED POLYESTER
TEAR-AID B REPAIR SET FOR PVC COATED POLYESTER
ADAPTION KIT FOR THULE / OMNISTOR / FIAMMA / DOMETIC 300 CM
RECHARGEABLE CORDLESS ELECTRIC PUMP

CORDLESS ELECTRIC PUMP

High Performance, Rechargeable Electric Air Pump Integrated 12V DC battery, standard 110-240 AC DC adaptor.



UNIVERSAL INNER TENT

STORMPOLE

For extra stability. Available in Steel, Aluminium and FibreTech Plus.

SAFELOCK SYSTEM KIT (SET OF 2)

Fits all current Dorema poled, full awning & porch awnings *(Except Davos Winter Porch)*

Now available for previous models for universal use. Consisting of 2 x straps, 2 x high tension springs and 2 x large steel pegs.



TRIPLE SAFELOCK SYSTEM KIT (SET OF 3)

All Dorema Full Air awnings are equipped with SafeLock System buckles to attach these straps. Consisting of 3 x straps, 3 x high tension springs and 3 x large steel pegs, the Triple SafeLock System Kit is available as a must have optional extra.

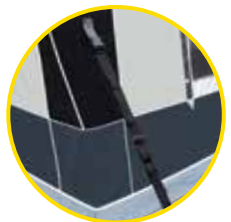

FRAMES

1 STEEL

The Steel frames offer great stability and are easy to assemble with the EasyGrip clamp system. When you have a seasonal pitch, we highly recommend to use our 28 mm steel frames for extra stability and a carefree stay.

2 ALU QUICK SYSTEM

ALU QUICK SYSTEM: The ultra light aluminium frame consists of only three major sections and three roof support poles. Each section contains a number of poles which are telescopic or are connected together with a spring system. All angle joints are made of steel.

- **Lightweight** (about half the weight of steel).
- **No rust**

3 FIBRETECH PLUS

The very latest in fibreglass frame technology, manufactured from 30 mm and 25,5 mm diameter tubing. This is a top quality woven fibreglass tube that is incredibly strong, easy to handle and simple to erect. The unique construction of the FibreTech Plus frame ensures a degree of flexibility with maximum strength at all times.

- **Ultra light and flexible**
- **Easy to erect**
- **Very stable**
- **Long life**
- **New EasyGrip clamp system**

4 EASY AIR FRAME SYSTEM (EAF)

The Easy Air Frame System consists of seamless TPU inner tubes that are high frequency welded on the ends. The inner tubes are protected within reinforced twin walled outer jackets. Inflation is achieved by an external single valve system that incorporates isolation valves which isolate each section of the main air frame. This also helps to preserve the air pressure within each inner tube. For rapid deflation, simply open the isolation valves and release the the air pressure from external multi-valves which are located at the front of the awning. The Easy Air Frame is only inflated to 8 -10 psi (max.) and makes the pitching of the air awning fast and simple.

1

2

3

4

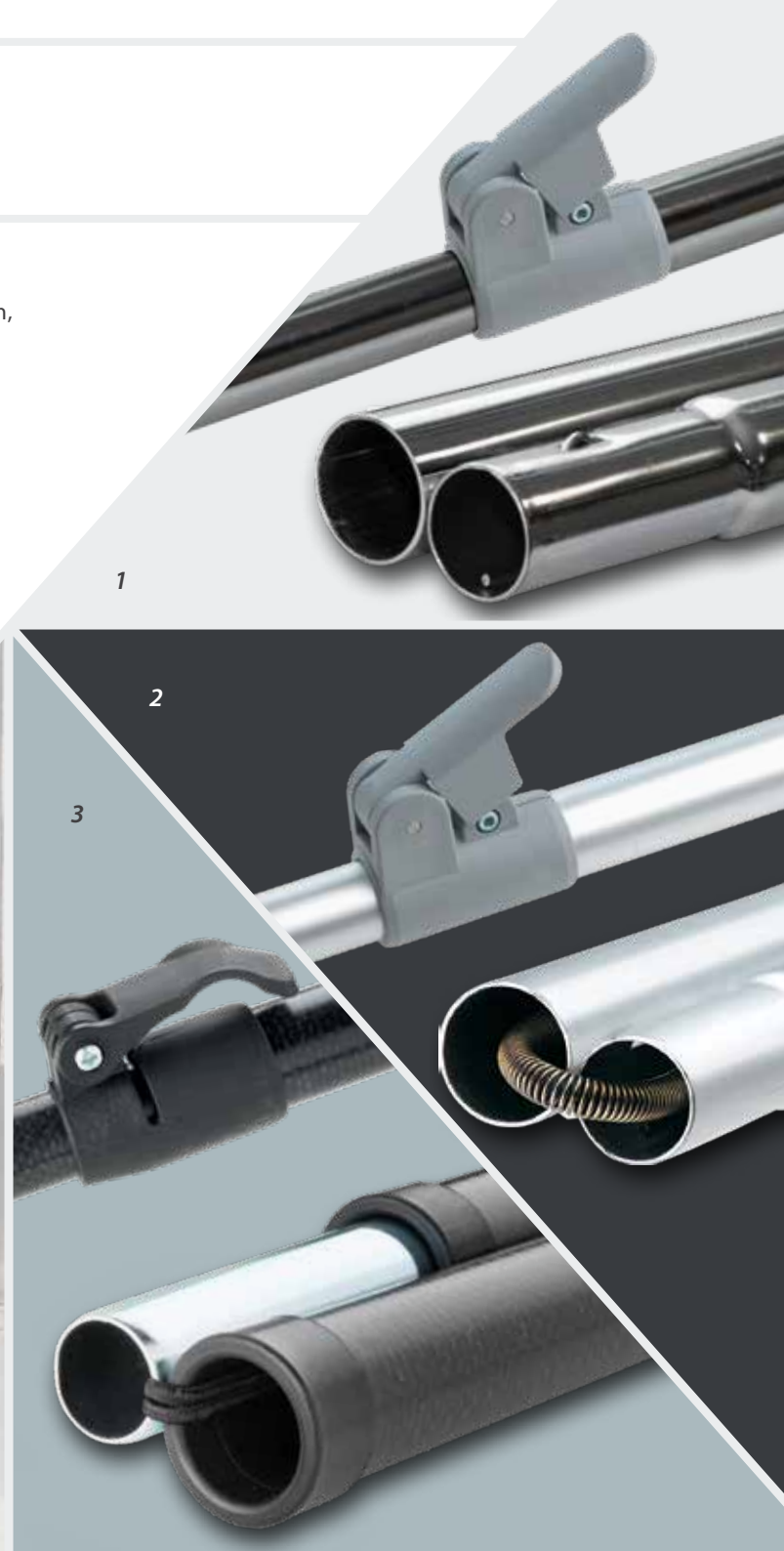

FRAME COMPOSITION

Awnings

AWNINGS (SIZE)

- 3-9: 3 Roof support poles & 3 Stormpoles
- 10-14: 5 Roof support poles & 3 Stormpoles
- 15-22: 5 Roof support poles & 5 Stormpoles

DAYTONA - GARDA RANGE



Size 3-9 Size 10-14 Size 15-19

EMERALD 270- PRESIDENT RANGE



Size 6-9 Size 10-14 Size 15-19

ROYAL 350 DE LUXE (SIZE)

- 8 & 9: 3 Roof support poles & 3 Stormpoles
- 10-12: 5 Roof support poles & 3 Stormpoles
- 13-22: 5 Roof support poles & 5 Stormpoles

ROYAL 350 DE LUXE



Size 8-9 Size 10-12 Size 18-22

ONYX 270



Size 9 - 12 Size 13 - 16



QUICKLOCK PADS

Supplied as standard with all Dorema full poled awnings, Davos winter porch, Vario, Panorama and Mondial Sun Canopies.

VERANDA, ROOF SUPPORT, STORM AND CANOPY POLES

VERANDA POLE STEEL, ADJUSTABLE (120 - 215 cm)
VERANDA POLE STEEL, ADJUSTABLE (195 - 280 cm)
VERANDA POLE STEEL, ADJUSTABLE (270 - 355 cm)
VERANDA POLE ALUMINIUM, ADJUSTABLE (120 - 215 cm)
VERANDA POLE ALUMINIUM, ADJUSTABLE (195 - 280 cm)
VERANDA POLE ALUMINIUM, ADJUSTABLE (270 - 355 cm)
VERANDA POLE FIBRETECH PLUS, ADJUSTABLE (115 - 210 cm)
VERANDA POLE FIBRETECH PLUS, ADJUSTABLE (210 - 285 cm)
VERANDA POLE FIBRETECH PLUS, ADJUSTABLE (270 - 340 cm)
ROOF SUPPORT POLE STEEL 25 mm, ADJUSTABLE UP TO 250 cm
ROOF SUPPORT POLE STEEL 28 mm, ADJUSTABLE UP TO 250 cm
ROOF SUPPORT POLE STEEL 25 mm, ADJUSTABLE 250 - 300 cm
ROOF SUPPORT POLE STEEL 28 mm, ADJUSTABLE 250 - 300 cm
ROOF SUPPORT POLE ALUMINIUM 25 mm, ADJUSTABLE UP TO 250 cm
ROOF SUPPORT POLE ALUMINIUM 28 mm, ADJUSTABLE UP TO 250 cm
ROOF SUPPORT POLE ALUMINIUM 28 mm, ADJUSTABLE 250 - 300 cm
ROOF SUPPORT POLE FIBRETECH PLUS, ADJUSTABLE UP TO 250 cm
ROOF SUPPORT POLE FIBRETECH PLUS, ADJUSTABLE (250 - 275 cm)

STORMPOLE STEEL 25 mm, ADJUSTABLE
STORMPOLE STEEL 28 mm, ADJUSTABLE
STORMPOLE ALUMINIUM, ADJUSTABLE
STORMPOLE FIBRETECH PLUS, ADJUSTABLE
CANOPY POLE STEEL, SIZE 5 - 9 (115 - 210 cm) *(COMPLETE SET)*
CANOPY POLE STEEL, SIZE 10 - 16 (210 - 295 cm) *(COMPLETE SET)*
CANOPY POLE STEEL, SIZE 17 - 19 (290 - 360 cm) *(COMPLETE SET)*
CANOPY POLE ALUMINIUM, SIZE 5 - 9 (115 - 210 cm) *(COMPLETE SET)*
CANOPY POLE ALUMINIUM, SIZE 10 - 16 (210 - 295 cm) *(COMPLETE SET)*
CANOPY POLE ALUMINIUM, SIZE 17 - 19 (290 - 360 cm) *(COMPLETE SET)*
CANOPY POLE FIBRETECH PLUS, SIZE 5 - 9 (115 - 205 cm) *(COMPLETE SET)*
CANOPY POLE FIBRETECH PLUS, SIZE 10 - 16 (210 - 290 cm) *(COMPLETE SET)*
CANOPY POLE FIBRETECH PLUS, SIZE 17 - 19 (270 - 340 cm) *(COMPLETE SET)*

- Veranda pole
- Stormpole
- Roof support pole
- Canopy pole

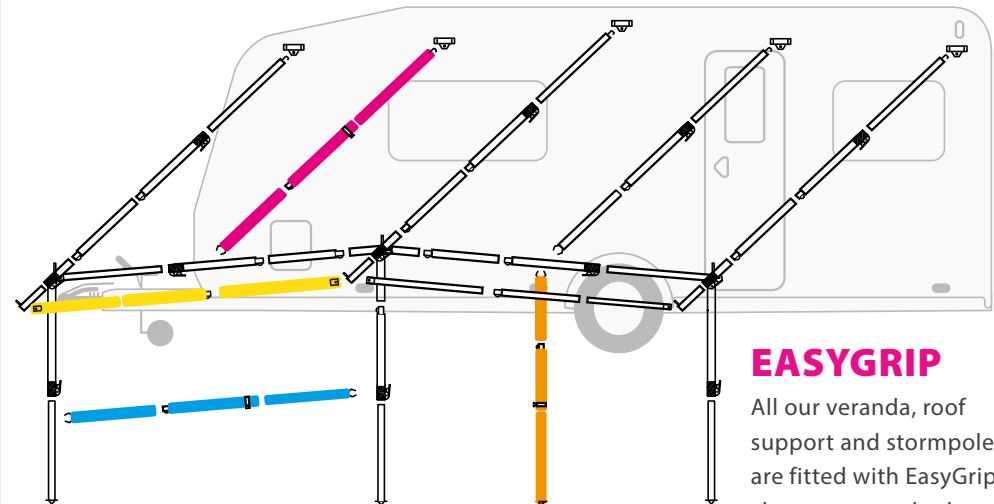

EASYGRIP

All our veranda, roof support and stormpoles are fitted with EasyGrip clamps as standard.



DOREMA UK LTD.
Pioneer Way,
Castleford
West Yorkshire,
WF10 5QU.
UNITED KINGDOM

Tel. 01977 - 555215

info@dorema.co.uk
www.dorema.co.uk

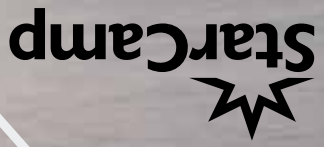

DOREMA UK LTD.

Pioneer Way,

Castleford

West Yorkshire,

WF10 5QU.

UNITED KINGDOM

Tel. 01977 - 555215

info@dorema.co.uk

www.dorema.co.uk

2023 - Dorema awnings have a policy of continuous improvement and we reserve the right to alter specifications and prices without prior notice.